

**Manuale utente - User Manual - Manuel de l'utilisateur
Bedienungsanleitung - Manual de usuario - Manual do utilizador
Εγχειρίδιο χρήστη**



K40912 - K40932

Videocitofono 7in supplementare vivavoce

7in hands-free video door entryphone

Portier-vidéo mains-libres 7in

Freisprechhaustelefon 7in

Videoportero manos libres 7in

Videoporteiro com monitor 7" alta-voz

7in hands-free video door entryphone

Caratteristiche e funzioni

Videocitofono

- Monitor 7"
- 5 tasti capacitivi a sfioramento retroilluminati
- Intercomunicante tra posti interni (della stessa famiglia).
- Luminosità, colore e contrasto regolabili
- Volume suoneria e volume di conversazione regolabili
- 6 melodie selezionabili

Dati tecnici:

- Ingresso DC: 24V
- Schermo LCD TFT da 7"
- Risoluzione LCD 800 (RGB) x 480
- Dimensioni (mm) 205 (L) x 128 (A) x 18 (P) (senza supporto a parete) 205 (L) x 128 (A) x 21,5 (P) (con supporto a parete)

Characteristics & functions

Video entryphone

- 7" Monitor
- 5 backlit capacitive soft buttons
- Intercom function between indoor units (of the same family)
- Adjustable brightness, colour and contrast
- Adjustable ringtone volume and conversation volume
- 6 selectable ringtones

Technical data:

- DC input: 24V
- 7" LCD TFT screen
- LCD resolution 800 (RGB) x 480
- Dimensions (mm) 205 (L) x 128 (H) x 18 (D) (without wall support) 205 (L) x 128 (H) x 21.5 (D) (with wall support)

Caractéristiques et fonctions

Portier-vidéo

- Moniteur 7 pouces
- 5 touches capacitives à effleurement rétroéclairées
- Appel intercommunicant entre postes intérieurs (de la même famille).
- Luminosité, couleur et contraste réglables
- Volume sonnerie et volume de conversation réglables
- 6 mélodies sélectionnables

Spécifications techniques :

- Entrée CC : 24V
- Écran LCD TFT 7 pouces
- Résolution LCD 800 (RGB) x 480
- Dimensions (mm) 205 (L) x 128 (A) x 18 (P) (sans support mural) 205 (L) x 128 (A) x 21,5 (P) (avec support mural)

Merkmale und Funktionen

Videohaustelefon

- 7"-Monitor
- 5 kapazitive, hinterbeleuchtete Touch-Tasten
- Internruffunktion zwischen Innenstellen (der gleichen Familie).
- Helligkeits-, Farb- und Kontrastregelung
- Einstellbare Rufton- und Gesprächslautstärke
- 6 wählbare Rufmelodien

Technische Daten:

- DC-Eingang: 24V
- 7"-LCD/TFT-Bildschirm
- LCD-Auflösung 800 (RGB) x 480
- Abmessungen (mm) 205 (L) x 128 (H) x 18 (T) (ohne Wandhalterung) 205 (L) x 128 (H) x 21,5 (T) (mit Wandhalterung)

Características y funciones

Videoportero

- Monitor 7"
- 5 botones capacitivos retroiluminados
- Intercomunicación entre aparatos internos (de la misma familia).
- Brillo, color y contraste ajustables
- Volumen del timbre y de conversación ajustable
- 6 tonos de llamada a elegir

Datos técnicos:

- Entrada DC: 24 Vcc
- Pantalla LCD TFT de 7"
- Resolución LCD 800 (RGB) x 480
- Medidas (mm) 205 (L) x 128 (A) x 18 (P) (sin soporte de pared) 205 (L) x 128 (A) x 21,5 (P) (con soporte de pared)

Características e funções

Videoporteiro

- Monitor 7"
- 5 teclas capacitivas sensíveis ao tato e retroiluminadas
- Intercomunicante entre postos internos (da mesma família).
- Luminosidade, cor e contraste reguláveis
- Volume da campainha e volume de conversação reguláveis
- 6 melodias selecionáveis

Dados técnicos:

- Entrada DC: 24V
- Ecrã LCD TFT de 7"
- Resolução LCD 800 (RGB) x 480
- Dimensões (mm) 205 (L) x 128 (A) x 18 (P) (sem suporte de parede) 205 (L) x 128 (A) x 21,5 (P) (com suporte de parede)

Χαρακτηριστικά και λειτουργίες

Θυροτηλεόραση

- Οθόνη 7"
- 5 χωρητικά πλήκτρα αφής με οπίσθιο φωτισμό
- Ενδοεπικοινωνία μεταξύ εσωτερικών σταθμών (της ίδιας οικογένειας).
- Ρυθμιζόμενη φωτεινότητα, χρώμα και αντίθεση
- Ρυθμιζόμενη ένταση ήχου κουδουνιού και ένταση ήχου συνομιλίας
- Δυνατότητα επιλογής 6 μελωδιών

Τεχνικά χαρακτηριστικά:

- Είσοδος DC: 24V
- Οθόνη LCD TFT 7"
- Ανάλυση LCD 800 (RGB) x 480
- Διαστάσεις (mm) 205 (Μ) x 128 (Υ) x 18 (Β) (χωρίς επιτοίχιο στήριγμα) 205 (Μ) x 128 (Υ) x 21,5 (Β) (με επιτοίχιο στήριγμα)

Videocitofono
Videohaustelefon
θηροτηλέοραση

Video entryphone
Videoportero

Portier-vidéo
Videoportero

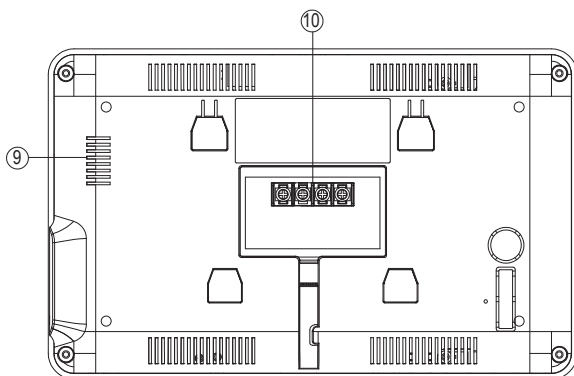
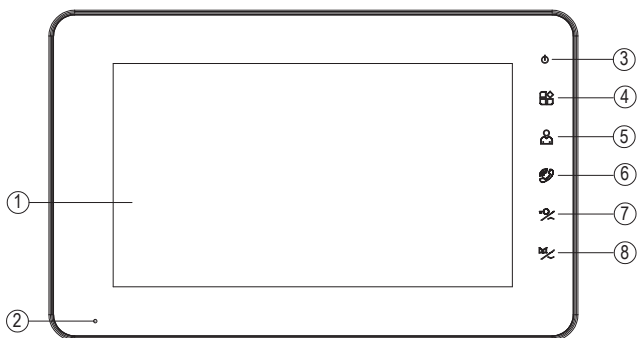

- 1 Schermo
- 2 Microfono
- 3 LED di segnalazione: Power ON (luce rossa)
- 4 Tasto Menu: per accedere alle impostazioni
- 5 Tasto Autoaccensione Monitor
- 6 Tasto di attivazione/disattivazione comunicazione
- 7 Tasto attivazione elettroserratura / "Freccia SU" in modalità configurazione
- 8 Tasto attivazione relè (apertura porta automatica o cancello) / "Freccia GIÙ" in modalità configurazione
- 9 Altoparlante
- 10 Morsetti connessioni (alimentazione, targa esterna)

- 1 Screen
- 2 Microphone
- 3 Indicator LEDs: Power ON (red light)
- 4 Menu button: to access settings
- 5 Monitor self-ignition button
- 6 Communication activation/deactivation button
- 7 Electric lock activation / "UP arrow" in configuration mode
- 8 Relay activation button (automatic door or gate opening) / "DOWN arrow" in configuration mode
- 9 Speaker
- 10 Terminal block power supply, entrance panel)

- 1 Écran
- 2 Microphone
- 3 Leds de signalisation : Power ON (led rouge)
- 4 Touche Menu : pour accéder aux paramètres
- 5 Touche Allumage automatique moniteur
- 6 Touche d'activation/désactivation communication
- 7 Touche d'activation électroserrure / « Flèche en haut » en mode configuration
- 8 Touche d'activation relais (ouverture porte automatique ou grille) / « Flèche en bas » en mode configuration
- 9 Haut-parleur
- 10 Bornier des connexions (alimentation, plaque de rue)

K40912 - K40932

- | | | |
|--|--|---|
| <ul style="list-style-type: none"> 1 Bildschirm 2 Mikrofon 3 Anzeige-LEDs: Versorgung EIN (rot) 4 Taste Menü: Öffnen der Einstellungen 5 Taste Monitor-Selbsteinschaltung 6 Taste Aktivierung/Deaktivierung der Kommunikation 7 Taste Elektroschloss-Aktivierung / "Pfeil AUF" im Konfigurationsmodus 8 Taste Relaisaktivierung (Automatiktür- oder Toröffnung) / "Pfeil AB" im Konfigurationsmodus 9 Lautsprecher 10 Anschlussklemmenleiste (Versorgung, Klingeltabelleu) | <ul style="list-style-type: none"> 1 Pantalla 2 Micrófono 3 LED de señalización: Alimentación ON (luz roja) 4 Botón Menú: para acceder a los ajustes 5 Botón Autoencendido monitor 6 Botón activación/desactivación comunicación 7 Botón activación electrocerradura / "Flecha ARRIBA" en el modo configuración 8 Botón activación relé (apertura puerta automática o cancela) / "Flecha ABAJO" en el modo configuración 9 Altavoz 10 Caja de bornes (alimentación, placa externa) | <ul style="list-style-type: none"> 1 Ecrã 2 Microfone 3 LED de sinalização: Power ON (luz vermelha) 4 Tecla Menu: para aceder às definições 5 Tecla de Autoacendimento do Monitor 6 Tecla de ativação/desativação da comunicação 7 Tecla de ativação do trinco elétrico/"Seta para CIMA" no modo de configuração 8 Tecla de ativação do relé (abertura da porta automática ou portão)/"Seta para BAIXO" no modo de configuração 9 Altifalante 10 Placa de terminais das ligações (alimentação, botoneira externa) |
|--|--|---|
-
- 1 Οθόνη
 - 2 Μικρόφωνο
 - 3 Λυχνία LED επισήμανσης: Ενεργοποίηση (κόκκινη λυχνία)
 - 4 Πλήκτρο μενού: για πρόσβαση στις ρυθμίσεις
 - 5 Πλήκτρο αυτόματης ενεργοποίησης οθόνης
 - 6 Πλήκτρο ενεργοποίησης/ απενεργοποίησης επικοινωνίας
 - 7 Πλήκτρο ενεργοποίησης ηλεκτρικής κλειδαριάς / «κάτω βέλους» στον τρόπο λειτουργίας διαμόρφωσης
 - 8 Πλήκτρο ενεργοποίησης ρελέ (άνοιγμα αυτόματης πόρτας ή καγκελόπορτας) / «πάνω βέλους» στον τρόπο λειτουργίας διαμόρφωσης
 - 9 Μεγάφωνο
 - 10 Κλέμα συνδέσεων (τροφοδοσίας, εξωτερικής μπουτονιέρας)

Installazione Videocitofono

Video entryphone installation

Installation du portier-vidéo



Installation des Videohaus- telefons



Instalación del videoportero

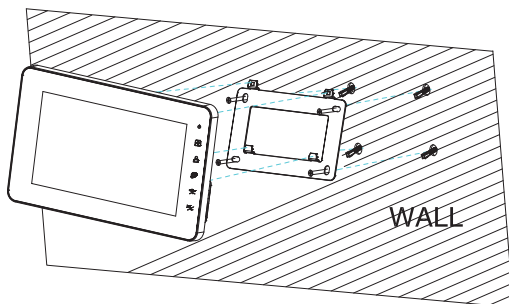
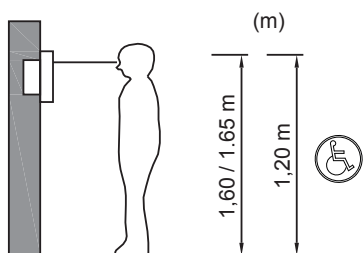

Instalação do videoporteiro

Εγκατάσταση θυροτηλεόρα- σης











- Si consiglia di provvedere ad una prima configurazione del dispositivo prima della connessione al bus di sistema.
- Affinché il sistema funzioni correttamente è necessario che ogni dispositivo abbia un proprio indirizzo univoco (ID).
Nel caso dei posti esterni, per configurazione dell'ID si intende la configurazione del jumper 10.
Nel caso dei videocitofoni, per configurazione dell'ID si intende:
- l'indicazione del dispositivo come Master (M) per il videocitofono principale;
- l'indicazione del dispositivo come Estensione 1 (1) o Estensione 2 (2) per i videocitofoni aggiuntivi.
- Si noti inoltre, che i videocitofoni proposti nei Kit mono e bifamiliari sono preconfigurati come Master, mentre i videocitofoni proposti come opzionali sono preconfigurati come Estensione 1.
- Una volta compiuti i passi precedenti si potrà procedere con installazione e connessione dei dispositivi al bus di famiglia.
- Una volta installato il Videocitofono si configurino, mediante l'icona [GENERAL]  i dispositivi CAM1, CAM2, CCTV1 e CCTV2 che possono essere consultati attraverso il tasto (5) .

- It is advisable to first configure the device before connecting to the system bus.
- For the system to function correctly, each device must have its own unique address (ID).
In the case of speech units, configuring the ID is done by configuring jumper 10. In the case of video entryphones, configuring the ID is done by:
- designation of the device as Master (M) for the main video entryphone;
- designation of the device as Extension 1 (1) or Extension 2 (2) for additional video entryphones.
- Please also note that the video entryphones included in the one-family and two-family kits are preconfigured as Master units, whereas the optional video entryphones are preconfigured as Extension 1.
- Once you have completed the previous steps, you can install and connect the devices to the family bus.
- Once the video entryphone has been installed, the next step is to configure, via the icon [GENERAL] , the CAM1, CAM2, CCTV1 and CCTV2 devices, from which the video feed can be checked by pressing button (5) .

- Il est conseillé de procéder à une première configuration du dispositif avant de le connecter au bus du système.
- Pour que le système fonctionne correctement, chaque dispositif doit avoir sa propre adresse univoque (ID).
En présence de postes extérieurs, la configuration de l'ID correspond à la configuration du jumper 10.
En présence de portiers-vidéo, la configuration de l'ID correspond à :
- l'indication du dispositif comme Maître (M) pour le portier-vidéo principal ;
- l'indication du dispositif comme Extension 1 (1) ou Extension 2 (2) pour les portiers-vidéo supplémentaires.
- Les portiers-vidéo faisant partie des Kits un ou deux usagers sont préconfigurés comme Maître alors que les portiers-vidéo proposés en option sont préconfigurés comme Extension 1.
- Après avoir accompli ces étapes, procéder à l'installation et à la connexion des dispositifs sur le bus de la famille.
- Après avoir installé le portier-vidéo, configurer à travers l'icône [GENERAL]  les dispositifs CAM1, CAM2, CCTV1 et CCTV2 qui peuvent être consultés en utilisant la touche (5) .

K40912 - K40932

- Vor dem Anschluss an den Systembus sollte das Gerät erstmals konfiguriert werden.
- Zur korrekten Funktionsweise des Systems muss jedes Gerät über eine eindeutige Adresse (ID) verfügen. Bei Außenstellen ist mit ID-Konfiguration die Konfiguration von Jumper 10 gemeint. Bei Videohaustelefonen ist mit ID-Konfiguration folgendes gemeint:
 - Angabe des Geräts als Master (M) für das Haupt-Videohaustelefon;
 - Angabe des Geräts als Erweiterung 1 (1) oder Erweiterung 2 (2) für die zusätzlichen Videohaustelefone.
 Es wird darauf hingewiesen, dass die im Einfamilien- und Zweifamilien-Set enthaltenen Videohaustelefone als Master, während die als optional angebotenen Videohaustelefone als Erweiterung 1 vorkonfiguriert sind.
- Nach Fertigstellung der vorgenannten Schritte können die Geräte installiert und an den Familienbus angeschlossen werden.
- Bei installiertem Videohaustelefon werden mit dem Symbol [ALLGEMEIN]  die über Taste (5) einsehbaren Geräte CAM1, CAM2, CCTV1 und CCTV2 konfiguriert. 
- Se recomienda realizar la primera configuración del dispositivo antes de la conexión al bus de sistema.
- Para que el sistema funcione correctamente, cada dispositivo debe tener su propia dirección unívoca (ID). En los aparatos externos, por configuración del ID se entiende la configuración del puente 10. En los videoporteros, por configuración del ID se entiende:
 - la indicación del dispositivo como Master (M) para el videoportero principal;
 - la indicación del dispositivo como Extensión 1 (1) o Extensión 2 (2) para los videoporteros adicionales.
 Además, cabe destacar que los videoporteros de los kits unifamiliares y bifamiliares están preconfigurados como Master, mientras que los videoporteros opcionales están preconfigurados como Extensión 1.
- Tras finalizar estos pasos, es posible realizar la instalación y la conexión de los dispositivos al bus de la familia.
- Una vez instalado el videoportero, mediante el icono [GENERAL]  deben configurarse los dispositivos CAM1, CAM2, CCTV1 y CCTV2 que se pueden consultar a través del botón (5) 
- Aconselha-se a proceder a uma primeira configuração do dispositivo antes da ligação ao bus de sistema.
- Para que o sistema funcione corretamente é necessário que cada dispositivo tenha o seu próprio endereço unívoco (ID). Em caso de postos externos, para a configuração do ID entende-se a configuração do jumper 10. Em caso de videoporteiros, para a configuração do ID entende-se:
 - a indicação do dispositivo como Master (M) para o videoporteiro principal;
 - a indicação do dispositivo como Extensão 1 (1) ou Extensão 2 (2) para os videoporteiros adicionais.
 De referir ainda que os videoporteiros propostos nos Kits mono e bifamiliares estão pré-configurados como Master, enquanto que os videoporteiros propostos como opcionais estão pré-configurados como Extensão 1.
- Uma vez cumpridos os passos anteriores, poder-se-á proceder à instalação e ligação dos dispositivos ao bus de família.
- Uma vez instalado o Videoportero, configuram-se através do ícone [GENERAL]  os dispositivos CAM1, CAM2, CCTV1 e CCTV2 que podem ser consultados através da tecla (5) 

- Συνιστάται να πραγματοποιήσετε μια πρώτη διαμόρφωση του μηχανισμού πριν από τη σύνδεση στο bus του συστήματος.
- Για να λειτουργεί σωστά το σύστημα, κάθε μηχανισμός πρέπει να έχει τη δική του μοναδική διεύθυνση (ID). Στην περίπτωση εξωτερικών σταθμών, ως διαμόρφωση του ID θεωρείται η διαμόρφωση του βραχυκυκλωτήρα 10. Στην περίπτωση θυροτηλεοράσεων, ως διαμόρφωση του ID θεωρείται:
 - ο ορισμός του μηχανισμού ως Master (M) για την κύρια θυροτηλεοράση,
 - ο ορισμός του μηχανισμού ως Επέκταση 1 (1) ή Επέκταση 2 (2) για τις πρόσθετες θυροτηλεοράσεις.
 Επίσης, σημειώνεται ότι οι προτεινόμενες θυροτηλεοράσεις στα κιτ μίας και δύο οικογενειών είναι προδιαμορφωμένες ως Master, ενώ οι προτεινόμενες θυροτηλεοράσεις ως προαιρετικές είναι προδιαμορφωμένες ως Επέκταση 1.
- Όταν ολοκληρώσετε τα προηγούμενα βήματα, μπορείτε να προχωρήσετε στην εγκατάσταση και τη σύνδεση των μηχανισμών στο bus της οικογένειας.
- Μετά την εγκατάσταση της θυροτηλεοράσης, διαμορφώνονται μέσω του εικονιδίου [ΓΕΝΙΚΑ]  οι μηχανισμοί CAM1, CAM2, CCTV1 και CCTV2 στους οποίους μπορείτε να ανατρέξετε μέσω του πλήκτρου (5) 

K40912 - K40932
Alimentatore multispina
 (per le versioni che lo prevedono)

Tensione di alimentazione AC: 100 V - 240 V, 0,6 A, 50 Hz / 60 Hz
 Uscita DC: 24V, 1A
 Dimensioni (mm): 43,5 (L) x 80,4 (A) x 38,5 (P)
 Adattatori spine AU / EU / UK / US

Multi-plug power supply
 (for applicable versions)

AC supply voltage: 100 V - 240 V, 0.6 A, 50 Hz / 60 Hz
 DC output: 24V, 1A
 Dimensions (mm): 43.5 (W) x 80.4(H) x 38.5 (D)
 AU / EU / UK / US plug adapters

Alimentation multifiches
 (selon les versions)

Tension d'alimentation CA : 100 V - 240 V, 0,6 A, 50 Hz / 60 Hz
 Sortie CC : 24V, 1A
 Dimensions (mm) : 43,5 (L) x 80,4 (A) x 38,5 (P)
 Adaptateurs pour fiches AU / EU / UK / US

Vielfachstecker-Netzteil
 (für dafür vorgesehene Versionen)

AC-Versorgungsspannung: 100 V - 240 V, 0,6 A, 50 Hz / 60 Hz
 DC-Ausgang: 24V, 1A
 Abmessungen (mm): 43,5 (L) x 80,4 (H) x 38,5 (T)
 Steckeradapter AU / EU / UK / US

Alimentador multiclavija
 (para las versiones que lo incluyen)

Tensión de alimentación: 100 Vca - 240 Vca, 0,6 A, 50 Hz / 60 Hz
 Salida: 24 Vcc, 1 A
 Medidas (mm): 43,5 (L) x 80,4 (A) x 38,5 (P)
 Adaptadores clavijas AU / EU / UK / UC

Alimentador multificha
 (para as versões que o preveem)

Tensão de alimentação AC: 100 V - 240 V, 0,6 A, 50 Hz / 60 Hz
 Saída DC: 24V, 1A
 Dimensões (mm): 43,5 (L) x 80,4 (A) x 38,5 (P)
 Adaptadores de fichas AU / EU / UK / US

Τροφοδοτικό πολλαπλών τάσεων

(για τις εκδόσεις στις οποίες προβλέπεται)

Τάση τροφοδοσίας AC: 100 V - 240 V, 0,6 A, 50 Hz / 60 Hz
 Έξοδος DC: 24V, 1A
 Διαστάσεις (mm): 43,5 (Μ) x 80,4 (Υ) x 38,5 (Β)
 Προσαρμογείς αρσενικών φικς AU / EU / UK / US

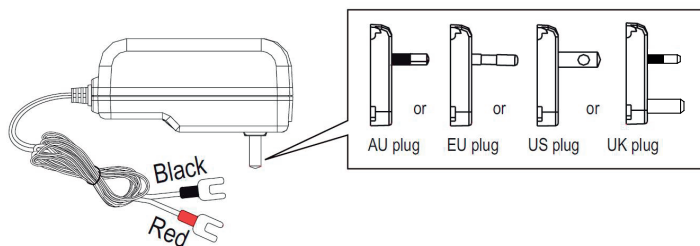

K40912 - K40932**Alimentatore per barra DIN****Caratteristiche tecniche**

- Alimentazione: 100 - 240 Vac 50/60Hz
- Consumo massimo 0,8 A
- Potenza dissipata 3,5 W
- Tensione di uscita (+/-) 24 Vdc nominali (ES1 e/o SELV).
- Corrente max erogata: 1 A
- Temperatura di funzionamento -5 °C +35 °C (da interno)
- 3 moduli 17,5 mm dimensioni 55x91x54 mm
- Simbolo per la CLASSE II

Power supply for DIN rail**Technical characteristics**

- Power supply: 100 - 240 Vac 50/60Hz
- Maximum power consumption 0.8 A
- Power dissipation 3.5 W
- Output voltage (+/-) 24 Vdc nominal (ES1 and/or SELV).
- Max. current output: 1 A
- Operating temperature -5 °C +35 °C (indoor)
- 3 x 17.5 mm modules, dimensions: 55x91x54 mm
- Symbol for CLASS II

Alimentation pour rail DIN**Caractéristiques techniques**

- Alimentation : 100 - 240 Vca 50/60 Hz
- Consommation maximale 0,8 A
- Puissance dissipée 3,5 W
- Tension de sortie (+/-) 24 Vcc nominaux (ES1 et/ou SELV).
- Courant maxi distribué : 1 A
- Température de fonctionnement -5 °C +35 °C (d'intérieur)
- 3 modules 17,5 mm, dimensions 53x91x54 mm
- Symbole pour la CLASSE II

Netzteil für DIN-Schiene**Technische Merkmale**

- Versorgung: 100 - 240 Vac 50/60Hz
- Maximale Stromaufnahme 0,8 A
- Verlustleistung 3,5 W
- Ausgangsbemessungsspannung (+/-) 24 Vdc (ES1 und/oder SELV).
- Max. abgegebene Stromstärke: 1 A
- Betriebstemperatur -5 °C +35 °C (Innenbereich)
- 3 Module 17,5 mm Abmessungen 55x91x54 mm
- Symbol für KLASSE II

Alimentador para carril DIN**Características técnicas**

- Alimentación: 100 - 240 Vca 50/60Hz
- Consumo máximo 0,8 A
- Potencia disipada 3,5 W
- Tensión de salida (+/-) 24 Vcc nominales (ES1 y/o SELV).
- Corriente má suministrada: 1 A
- Temperatura de funcionamiento -5 °C +35 °C (de interior)
- 3 módulos 17,5 mm medidas 55x91x54 mm
- Símbolo para la CLASE II

Alimentador para barra DIN**Características técnicas**

- Alimentação: 100 - 240 Vac 50/60Hz
- Consumo máximo 0,8 A
- Potência dissipada 3,5 W
- Tensão de saída (+/-) 24 Vdc nominais (ES1 e/ou SELV).
- Corrente máx. fornecida: 1 A
- Temperatura de funcionamento -5 °C +35 °C (interior)
- 3 módulos 17,5 mm dimensões 55x91x54 mm
- Símbolo para a CLASSE II

Τροφοδοτικό για ράβδο DIN**Τεχνικά χαρακτηριστικά**

- Τροφοδοσία: 100 - 240 Vac 50/60Hz
- Μέγιστη κατανάλωση 0,8 A
- Απώλεια ισχύος 3,5 W
- Ονομαστική τιμή τάσης εξόδου (+/-) 24 Vdc (ES1 ή/και SELV).
- Μέγ. παρεχόμενο ρεύμα: 1 A
- Θερμοκρασία λειτουργίας -5°C +35°C (για εσωτερικό χώρο)
- 3 μονάδες 17,5 mm διαστάσεων 55x91x54 mm
- Σύμβολο για την ΚΑΤΗΓΟΡΙΑ II

Uscita • Output • Sortie •
Ausgang • Salida • Saída •
Εξόδος

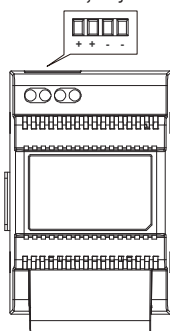

Ingresso • Input • Entrée •
Eingang • Entrada • Entrada •
Είσοδος



Barra DIN
DIN rail
Rail DIN
DIN-Schiene
Carril DIN
Barra DIN
Ράβδος DIN

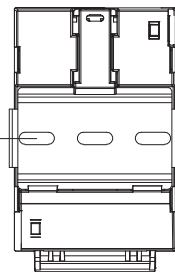

Distanza massima tra uscita DC alimentatore DIN e videocitofono • Maximum distance between DC output of DIN power supply and video entryphone
Distance maximale entre sortie CC alimentation DIN et portier-vidéo • Maximaler Abstand zwischen DC-Ausgang von DIN-Netzteil und Videohaustelefon
Distancia máxima entre salida CC alimentador DIN y videoportero • Distância máxima entre a saída DC do alimentador DIN e o videoporteiro
Μέγιστη απόσταση μεταξύ εξόδου DC τροφοδοτικού DIN και θυροτηλεόρασης

• Tipo di cavo • Type of cable • Type de câble
• Kabeltyp • Tipo de cable • Tipo de cabo
• Τύπος καλωδίου

0,75 mm²

• Lunghezza del collegamento • Connection length • Longueur de la connexion
• Anschlusslänge • Longitud de la conexión • Comprimento da ligação
• Μήκος σύνδεσης

15 m

K40912 - K40932

Alimentatore per barra DIN: Installazioni previste
Power supply for DIN rail: Possible installations
Alimentation pour rail DIN : Installations prévues
Netzteil für DIN-Schiene: Vorgesehene Installationen
Alimentador para carril DIN Montajes previstos
Alimentador para barra DIN: Instalações previstas
Τροφοδοτικό για ράβδο DIN: Προβλεπόμενες εγκαταστάσεις

Installazione su centralino
 Installation on switchboard
 Installation sur coffret
 Installation in Schaltkasten
 Montaje en centralita
 Instalação na central
 Εγκατάσταση σε κεντρική μονάδα

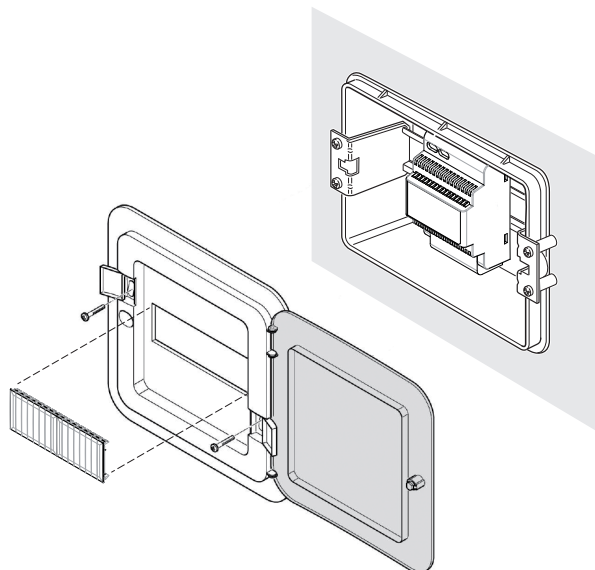

Installazione su scatola di derivazione
 Installation on junction box
 Installation sur boîte de dérivation
 Installation in Abzweigdose
 Montaje en caja de derivación
 Instalação na caixa de derivação
 Εγκατάσταση σε κουτί διακλάδωσης

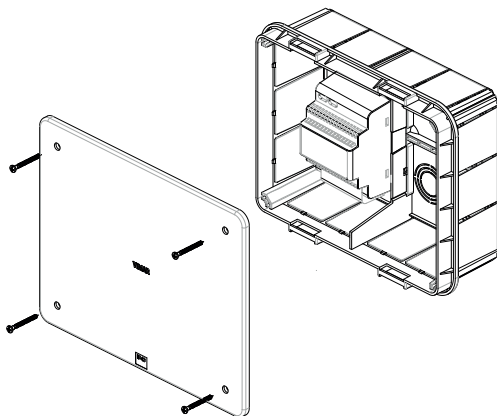

K40912 - K40932

Telecamera TVCC (optional): Installazione

Ai terminali CCTV e GND del posto esterno è possibile collegare telecamera Vimar 46CAM.136B.8.

Lunghezza massima: 100 m con Cavo SYV75-3 / RG59.

Installation einer Videoüberwachungskamera (optional)

An die Klemmen CCTV und GND der Außenstelle kann die Videokamera Vimar 46CAM.136B.8 angeschlossen werden.

Max. Länge: 100 m mit Kabel SYV75-3 / RG59

Εγκατάσταση κάμερας TVCC (προαιρετική)

Στους ακροδέκτες CCTV και GND του εξωτερικού σταθμού μπορεί να συνδεθεί κάμερα Vimar 46CAM.136B.8.

Μέγιστο μήκος: 100 m με καλώδιο SYV75-3 / RG59

Installation of a CCTV camera (optional)

The Vimar 46CAM.136B.8 camera can be connected to the CCTV and GND terminals of the speech unit.

Maximum length: 100 m with SYV75-3 / RG59 cable

Montaje de una cámara CCTV (opcional)

A los terminales CCTV y GND del aparato externo se puede conectar la cámara Vimar 46CAM.136B.8.

Longitud máxima: 100 m con cable SYV75-3 / RG59

Installation d'une caméra CCTV (en option)

Possibilité de brancher la caméra Vimar 46CAM.136B.8 aux cosses CCTV et GND du poste extérieur.

Longueur maximale : 100 m avec câble SYV75-3 / RG59

Instalação de uma câmara CCTV (opcional)

Aos terminais CCTV e GND do posto externo é possível ligar a câmara Vimar 46CAM.136B.8.

Comprimento máximo: 100 m com Cabo SYV75-3 / RG59

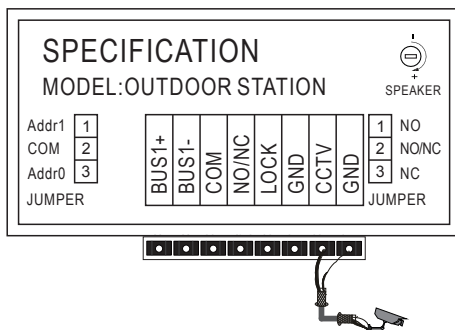

K40912 - K40932

Schema di collegamento impianto monofamiliare

Single-family system connection diagram

Schéma de connexion installation un usager

Schaltbild der Einfamilienanlage

Esquema de conexión de una instalación unifamiliar

Esquema de ligação do sistema monofamiliar

Διάγραμμα σύνδεσης εγκατάστασης μίας οικογένειας

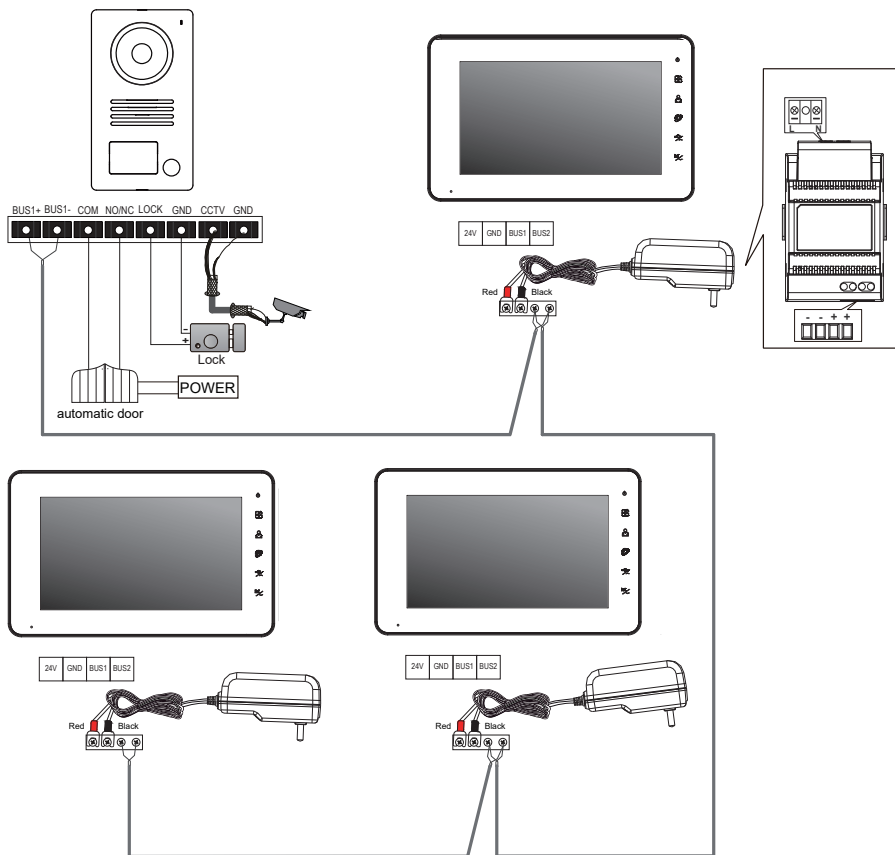

Sezione minima conduttori • Minimum conductor section • Section minimale conducteurs • Mindestleitungsdurchmesser • Sección mínima conductores • Secção mínima condutores • Ελάχιστη διατομή του καλωδίου	
fino a 50m • up to 50m • jusqu'à 50m • bis 50m • hasta 50m • até 50m • έως 50m (*)	fino a 100m • up to 100m • jusqu'à 100m • bis 100m • hasta 100m • até 100m • έως 100m (*)
0.75 mm ²	1 mm ²
* Distanza tra la targa esterna più lontana e l'ultimo videocitofono interno * Distance between the outdoor entrance panel and the last indoor video entryphone * Distance entre la plaque de rue la plus éloignée et le dernier portier-vidéo intérieur * Abstand zwischen dem entferntesten Klingeltableau und dem letzten Videohaustelefon * Distancia entre la placa externa más lejana y el último videoportero interno * Distância entre a botoneira externa mais afastada e o último videoporteiro interno * Απόσταση μεταξύ της πιο απομακρυσμένης εξωτερικής μπουτονιέρας και της τελευταίας εσωτερικής θυροτηλεόρασης	

K40912 - K40932**Note:**

1. La lunghezza minima del cavo tra due videocitofoni deve essere 5m.
2. Alimentatore multispina: sono presenti due forchette, la rossa deve essere collegata al morsetto 24V e la nera al morsetto GND del videocitofono.
3. Nei sistemi composti da due posti esterni, qualora fosse già attiva una comunicazione tra posto esterno e videocitofono, in caso di chiamata dall'altro posto esterno, un segnale di occupato (sequenza di bip) segnalerà la necessità di attendere che il sistema sia libero.

Anmerkungen:

1. Die min. Kabellänge zwischen zwei Videohaustelefonen beträgt 5m.
2. Vielfachstecker-Netzteil: Von den zwei Gabeln muss die rote an die 24 V Klemme und die schwarze an die GND-Klemme des Videohaustelefons angeschlossen werden.
3. Falls in Systemen mit Außenstellen bereits eine Kommunikation zwischen Außenstelle und Videohaustelefon ablaufen sollte, meldet beim Ruf von der anderen Außenstelle ein Besetzt-Zeichen (Sequenz von Pieptönen), dass auf die Freigabe des Systems gewartet werden muss.

Σημειώσεις:

1. Το ελάχιστο μήκος του καλωδίου μεταξύ δύο θυροτηλεοράσεων πρέπει να είναι 5m.
2. Τροφοδοτικό πολλαπλών τάσεων: υπάρχουν δύο διχάλες. Η κόκκινη πρέπει να συνδέεται στην επαφή κλέμας 24V και η μαύρη πρέπει να συνδέεται στην επαφή κλέμας GND της θυροτηλεοράσης.
3. Στα συστήματα που αποτελούνται από δύο εξωτερικούς σταθμούς, εάν έχει ήδη ενεργοποιηθεί η επικοινωνία μεταξύ εξωτερικού σταθμού και θυροτηλεοράσης, στην περίπτωση κλήσης από άλλο εξωτερικό σταθμό το σήμα κατειλημμένου (ακολουθία σημάτων μπιπ) υποδεικνύει ότι ο χρήστης πρέπει να περιμένει να ελευθερωθεί το σύστημα.

Notes:

1. The minimum cable length between two video entryphones is 5 m.
2. Multi-plug power supply: there are two forks, the red one must be connected to the 24V terminal and the black one to the GND terminal of the video entryphone.
3. In systems consisting of two speech units, if a call is made from a speech unit while communication is already in progress between the other speech unit and the video entryphone, a busy signal (sequence of beeps) will indicate that the caller needs to wait for the line to become available.

Notas:

1. La longitud mínima del cable entre dos videoporteros debe ser de 5 m.
2. Alimentador multiclavija: hay dos horquillas - la roja debe conectarse al borne de 24 V y la negra al borne GND del videoportero.
3. En los sistemas formados por dos aparatos externos, si ya estuviera activada una comunicación entre aparato externo y videoportero, en caso de llamada desde el otro aparato externo, la señal correspondiente (secuencia de señales acústicas) indica que hay que esperar que el sistema esté libre.

Remarques :

1. Le câble entre deux portiers-vidéo doit mesurer au moins 5 m.
2. Alimentation multifiches : deux fourchettes sont présentes ; brancher la rouge sur la borne 24 V et la noire sur la borne GND du portier-vidéo.
3. Sur les systèmes comprenant deux postes extérieurs, si un poste extérieur est déjà en communication avec le portier-vidéo, en cas d'appel provenant de l'autre poste extérieur, un signal occupé (répétition de bips) mettra en attente jusqu'à ce que le système soit libre.

Notas:

1. O comprimento mínimo do cabo entre dois videoporteiros deve ser de 5m.
2. Alimentador multificha: estão presentes duas forquetas, a vermelha deve ser ligada ao terminal de 24 V e a preta deve ser ligada ao terminal GND do videoportero.
3. Nos sistemas compostos por dois postos externos, caso já esteja ativa uma comunicação entre o posto externo e o videoporteiro, em caso de chamada de outro posto externo, um sinal de ocupado (sequência de bips) assinalará a necessidade de aguardar que o sistema esteja livre.

K40912 - K40932

Schema di collegamento impianto bifamiliare con due targhe e fino a tre monitor per Famiglia

Two-family system connection diagram with two panels and up to three monitors per user

Schéma de connexion installation deux usagers avec deux plaques et jusqu'à trois moniteurs par usager

Schaltbild einer Zweifamilienanlage mit zwei Klingeltableaus und bis zu drei Monitoren pro Benutzer

Esquema de conexión de una instalación bifamiliar con dos placas y hasta tres monitores por usuario

Esquema de ligação do sistema bifamiliar com duas botoneiras e até três monitores por utilizador

Διάγραμμα σύνδεσης εγκατάστασης δύο οικογενειών με δύο μπουτονιέρες και έως τρεις οθόνες ανά χρήστη

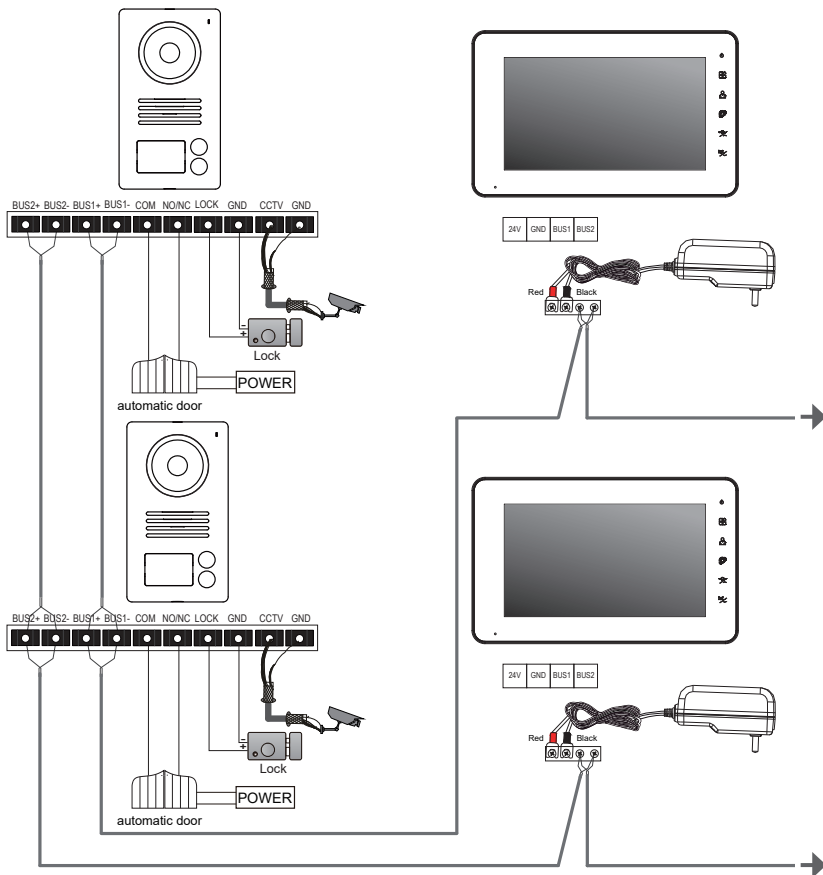

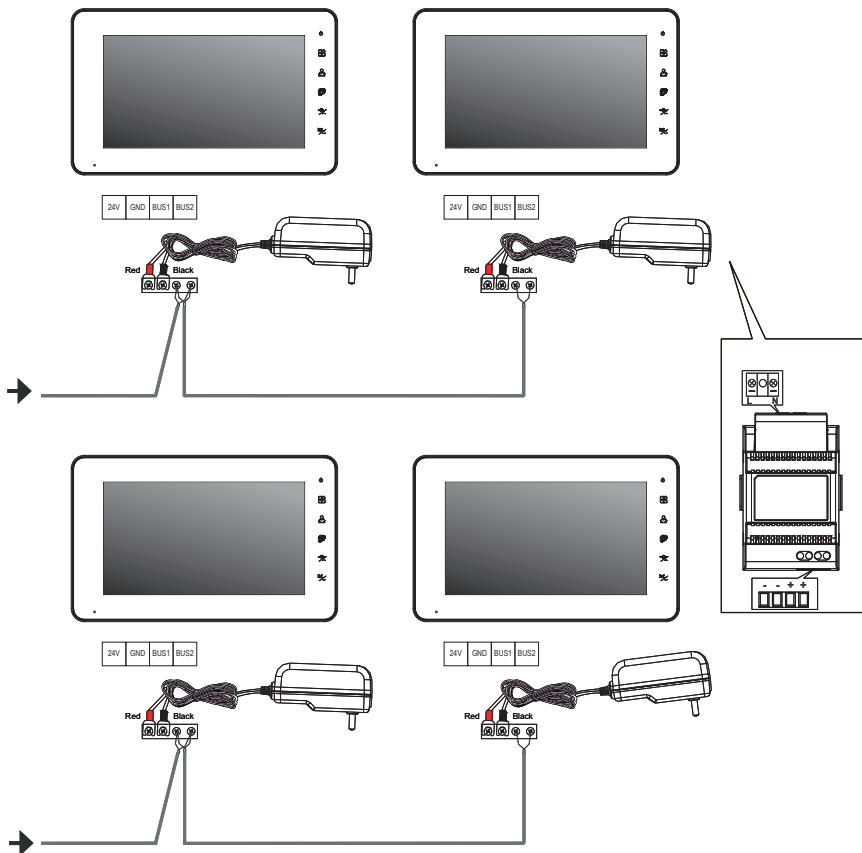

K40912 - K40932

Funzionamento

Il videocitofono può essere utilizzato attraverso i tasti a sfioramento (soft buttons).

Si noti che i tasti possono assumere diverse funzionalità a seconda della modalità di utilizzo del dispositivo.

In condizioni di stand-by il videocitofono mostrerà il led rosso (3)  attivo e lo schermo risulterà spento.

Funktionsweise

Das Videohaustelefon kann mit den Touch-Tasten (Soft Buttons) bedient werden.

Je nach Anwendungsmodus des Geräts können die Tasten unterschiedliche Funktionen annehmen.

Im Standby-Zustand ist die rote LED (3) des Videohaustelefons  aktiviert und der Bildschirm erloschen.

Λειτουργία

Η θυροτηλεόραση μπορεί να χρησιμοποιηθεί μέσω των πλήκτρων αφής (soft button).

Λάβετε υπόψη ότι τα πλήκτρα μπορούν να εκτελούν διαφορετικές λειτουργίες ανάλογα με τον τρόπο χρήσης του μηχανισμού.

Στην κατάσταση αναμονής, η κόκκινη λυχνία led της θυροτηλεόρασης (3)  θα είναι αναμμένη και η οθόνη θα είναι σβηστή.

Operation

The video entryphone is operated using the soft buttons.

Note that the buttons can assume different functions depending on the current operating mode of the device.

In stand-by condition, the video entryphone illuminates the red LED (3)  and the screen is off.

Funcionamiento

El videoportero se puede utilizar a través de los botones (soft buttons).

Cabe destacar que los botones pueden tener funciones distintas según el modo de utilización del dispositivo.

En condiciones de stand-by el videoportero muestra el led rojo (3)  activado y la pantalla apagada.

Fonctionnement

Le portier-vidéo peut être utilisé à travers les touches à effleurement (soft buttons).

Les touches peuvent remplir plusieurs fonctions selon le mode d'utilisation du dispositif.

En mode veille, la led rouge (3)  du portier-vidéo sera allumée alors que l'écran restera éteint.

Funcionamento

O videoporteiro pode ser utilizado através das teclas sensíveis ao tato (soft buttons).

De notar que as teclas podem assumir diversas funcionalidades consoante o modo de utilização do dispositivo.

Em condições de standby o videoporteiro mostrará o led vermelho (3)  ativo e o ecrã estará desligado.

Configurazione

Se in condizioni di stand-by si sfiora il tasto (4)  il Videocitofono entra in modalità configurazione: sul monitor apparirà il menù come indicato nella figura riportata sotto.

Konfiguration

Durch den Touch der Taste (4)  bei Videohaustelefon im Standby-Zustand wird der Konfigurationsmodus aufgerufen: Am Monitor erscheint das unten abgebildete Menü.

Διαμόρφωση

Εάν στην κατάσταση αναμονής πατήσετε το πλήκτρο (4) , η θυροτηλεόραση θα μεταβεί στον τρόπο λειτουργίας διαμόρφωσης: στην οθόνη θα εμφανιστεί το μενού που φαίνεται στην παρακάτω εικόνα.

Configuration

In stand-by condition, on pressing soft button (4)  the video entryphone will enter configuration mode: the menu shown in the figure below will appear on the monitor.

Configuración

Si estando en stand-by se toca el botón (4)  el videoportero entra en el modo de configuración: en pantalla aparece el menú que se muestra en la figura siguiente.

Configuration

En effleurant la touche (4)  en mode veille, le portier-vidéo passe au mode configuration : le moniteur affiche le menu, comme l'indique la figure ci-dessous.

Configuração

Se, em condições de standby, se tocar na tecla (4)  o Videoporteiro entra no modo de configuração: no monitor aparece o menu indicado na figura abaixo.

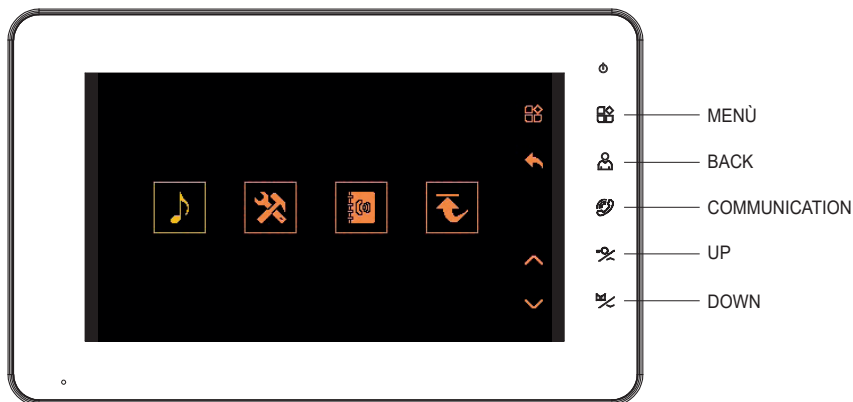

K40912 - K40932

Si noti che sulla parte destra dello schermo, in corrispondenza di ogni tasto è riportato un simbolo grafico con l'indicazione della funzione associata:

- Al tasto (4) è associata la funzione di consultazione menù.
- Al tasto (5) è associata la funzione di uscita dal menù in uso.
- Al tasto (6) non è associata alcuna funzione.
- Al tasto (7) è associata la funzione di selettore (freccia verso l'alto).
- Al tasto (8) è associata la funzione di selettore (freccia verso il basso).

Agendo sui tasti di selezione (7) e (8) si andrà a selezionare la relativa icona.

Quando l'icona è selezionata è evidenziata in giallo.

Per attivare la selezione ed entrare nel sotto-menù si sfiori il tasto (4) .

An der rechten Seite des Bildschirms befindet sich neben jeder Taste ein grafisches Symbol mit Angabe der zugeordneten Funktion:

- Der Taste (4) ist die Funktion Blättern im Menü zugewiesen.
- Der Taste (5) ist die Funktion Beenden des aktuellen Menüs zugewiesen.
- Der Taste (6) ist keine Funktion zugewiesen.
- Der Taste (7) ist die Funktion Wahlschalter zugewiesen (Pfeil nach oben).
- Der Taste (8) ist die Funktion Wahlschalter zugewiesen (Pfeil nach unten).

Anhang der Wahlkosten (7) und (8) wird das entsprechende Symbol gewählt.

Das angewählte Symbol ist gelb markiert.

Durch den Touch der Taste (4) wird die Auswahl aktiviert und das Untermenü aufgerufen.

Note that on the right-hand side of the screen, in correspondence with each button, there is a graphic symbol indicating the function associated with that button:

- Button (4) is associated with the menu access function.
- Button (5) is associated with the exit current menu function.
- Button (6) is not associated with any function.
- Button (7) is associated with the option selection function (up arrow).
- Button (8) is associated with the option selection function (down arrow).

Use the option selection buttons (7) and (8) to select the desired icon.

Once an icon is selected, it will be highlighted in yellow.

To activate the selected icon and enter the relative sub-menu, press button (4) .

A la derecha de la pantalla, al lado de cada botón hay un símbolo gráfico que indica la función asociada:

- Al botón (4) está asociada la función de consulta del menù.
- Al botón (5) está asociada la función de salida del menù actual.
- Al botón (6) no está asociada ninguna función.
- Al botón (7) está asociada la función de selector (flecha hacia arriba).
- Al botón (8) está asociada la función de selector (flecha hacia abajo).

Con los botones de selección (7) y (8) se selecciona el icono correspondiente.

El icono seleccionado se resalta en amarillo.

Para activar la selección y entrar en el submenù, toque el botón (4) .

Un symbole graphique indiquant la fonction associée s'affiche sur la partie droite de l'écran, face à chaque touche :

- La touche (4) est associée à la fonction de consultation du menu.
- La touche (5) est associée à la fonction permettant de quitter le menu ouvert.
- La touche (6) n'est associée à aucune fonction.
- La touche (7) est associée à la fonction de sélecteur (flèche vers le haut).
- La touche (8) est associée à la fonction de sélecteur (flèche vers le bas).

Agir sur les touches de sélection (7) et (8) pour sélectionner l'icône correspondante.

Lorsque l'icône est sélectionnée, elle devient jaune.

Pour valider la sélection et entrer dans le sous-menu, effleurer la touche (4) .

De notar que, na parte direita do ecrã, no local correspondente a cada tecla, está um símbolo gráfico com a indicação da função associada:

- À tecla (4) está associada a função de consulta dos menus.
- À tecla (5) está associada a função de saída do menu que está a ser utilizado.
- À tecla (6) não está associada nenhuma função.
- À tecla (7) está associada a função de seletor (seta para cima).
- À tecla (8) está associada a função de seletor (seta para baixo).





Atuando nas teclas de seleção (7) e (8) seleciona-se o respetivo ícone.



Quando o ícone é selecionado, é evidenciado a amarelo.

Para ativar a seleção e entrar no sub-menu, toque na tecla (4) .

K40912 - K40932

Λάβετε υπόψη ότι στο δεξί τμήμα της οθόνης, σε κάθε πλήκτρο αντιστοιχεί ένα γραφικό σύμβολο με την ένδειξη της λειτουργίας που έχει αντιστοιχιστεί:

- Στο πλήκτρο (4)  αντιστοιχίζεται η λειτουργία ανοίγματος μενού.
- Στο πλήκτρο (5)  αντιστοιχίζεται η λειτουργία εξόδου από το μενού που χρησιμοποιείται.
- Στο πλήκτρο (6)  δεν αντιστοιχίζεται καμία λειτουργία.
- Στο πλήκτρο (7)  αντιστοιχίζεται η λειτουργία επιλογέα (βέλος προς τα πάνω).
- Στο πλήκτρο (8)  αντιστοιχίζεται η λειτουργία επιλογέα (βέλος προς τα κάτω).

Πατώντας τα πλήκτρα επιλογής (7)  και (8)  μεταβαίνετε στην επιλογή του σχετικού εικονιδίου.



Όταν το εικονίδιο είναι επιλεγμένο, επισημαίνεται με κίτρινο χρώμα.

Για να ενεργοποιήσετε την επιλογή και να ανοίξετε το υπομενού, πατήστε το πλή-

κτρο (4) .



K40912 - K40932

Configurazione > melodie

Selezionando l'icona [suoneria]  e sfiorando il tasto (4)  si accederà al sotto-menù:



- Selezione della melodia per le chiamate.
- Impostazione della durata della suoneria per chiamate da Posto Esterno (*).
- Impostazione della durata della suoneria per chiamate da Posto Interno (Intercomunicante) (*).

Konfiguration > Melodien

Durch Auswahl des Symbols [Rufton]  und Touch der Taste (4)  wird folgendes Untermenü aufgerufen:

- Einstellung der Rufmelodie.
- Einstellung der Rufdauerdauer für Anrufe der Außenstelle (*).
- Einstellung der Rufdauerdauer für Anrufe der Innenstelle (Internruf) (*).

Διαμόρφωση > μελωδίες

Επιλέγοντας το εικονίδιο [κουδούνι]  και πατώντας το πλήκτρο (4)  μπορείτε να αποκτήσετε πρόσβαση στο υπομενού:



- Επιλογή μελωδίας για τις κλήσεις.
- Ρύθμιση διάρκειας κουδουνιού για κλήσεις από εξωτερικό σταθμό (*).
- Ρύθμιση διάρκειας κουδουνιού για κλήσεις από εσωτερικό σταθμό (κλήση ενδοεπικοινωνίας) (*).

(*) funzione disponibile nei Posti Interni con tracciabilità _____ X X ____, dove XX è maggiore o uguale a 05.

(*) verfügbare Funktion in Innenstellen mit Rückverfolgbarkeit _____ X X ____, wobei XX größer oder gleich 05 ist.



(*) η λειτουργία διατίθεται για εσωτερικούς σταθμούς με παρακολούθηση _____ X X ____, όπου XX είναι ένας αριθμός μεγαλύτερος ή ίσος με 05.

Configuration > ringtones

Select the icon [ringtone]  and touch the key (4)  to access the sub-menu:

- Selecting a ringtone for calls.
- Setting the duration of the ringtone for calls from an Speech Unit (*).
- Setting the duration of the ringtone for calls from an Indoor Unit (Intercom) (*).

Configuración > tonos



Al seleccionar el icono [timbre]  y tocar el botón (4)  se accede al submenú:

- Selección del tono para las llamadas.
- Ajuste de la duración del timbre para llamadas desde aparato externo (*).
- Ajuste de la duración del timbre para llamadas desde aparato interno (intercomunicante) (*).

(*) función available in Indoor Units with traceability _____ X X ____, where XX is 05 or more.



(*) función disponible en los aparatos internos con trazabilidad _____ X X ____, donde XX es mayor o igual a 05.

Configuration > mélodies

Sélectionner l'icône [sonnerie]  et effleurer la touche (4)  pour accéder au sous-menu :

- Sélection de la mélodie pour les appels.
- Réglage de la durée de la sonnerie pour les appels provenant d'un Poste Extérieur (*).
- Réglage de la durée de la sonnerie pour les appels provenant d'un Poste Intérieur (Intercommunicant) (*).

Configuração > melodias

Selecionando o ícone [toque]  e tocando na tecla (4)  acede-se ao submenu:

- Seleção da melodia para as chamadas.
- Definição da duração do toque para chamadas de Posto Externo (*).
- Definição da duração do toque para chamadas de Posto Interno (Intercomunicante) (*).

(*) fonction disponible sur les Postes Intérieurs avec traçabilité _____ X X ____, où XX est supérieur ou égal à 05.

(*) função disponível nos Postos Internos com rastreabilidade _____ X X ____, sendo que XX é maior ou igual a 05.

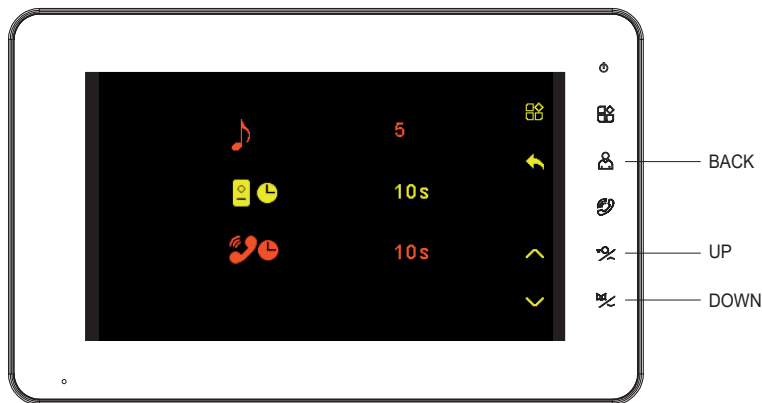

Nella schermata riportata in figura:

Al tasto (4) è associata la funzione di selezionare l'icona relativa a ciascuna funzione rappresentata: premendo ripetutamente si selezionano ciclicamente le icone.

Al tasto (5) è associata la funzione di uscita dal menù

Al tasto (6) non è associata alcuna funzione

Al tasto (7) è associata la funzione di selettore (freccia verso l'alto)

Al tasto (8) è associata la funzione di selettore (freccia verso il basso)

Significato delle icone:

- Icona : agendo sui tasti (7) e (8) si seleziona la melodia.
- Icona : agendo sui tasti (7) e (8) si seleziona la durata della suoneria per chiamate da Posto Esterno.
- Icona : agendo sui tasti (7) e (8) si seleziona la durata della suoneria per chiamate da Posto Interno (Intercomunicante).

In the screen shown in the figure:

Button (4) is associated with selecting the icon relating to each function represented: press repeatedly to scroll through the list of icons.

Button (5) is associated with the exit menu function

Button (6) is not associated with any function

Button (7) is associated with the option selection function (up arrow)

Button (8) is associated with the option selection function (down arrow)

Meanings of the icons:

- Icon : press buttons (7) and (8) to select the ringtone.
- Icon : press buttons (7) and (8) to select the duration of the ringtone for calls from a Speech Unit.
- Icon : press buttons (7) and (8) to select the duration of the ringtone for calls from an Indoor Unit (Intercom).

Selon la page représentée sur la figure :

La touche (4) est associée à la fonction de sélection de l'icône correspondant à chaque fonction représentée : appuyer dessus plusieurs fois pour sélectionner cycliquement les icônes.

La touche (5) est associée à la fonction permettant de quitter le menu.

La touche (6) n'est associée à aucune fonction.

La touche (7) est associée à la fonction de sélecteur (flèche vers le haut).

La touche (8) est associée à la fonction de sélecteur (flèche vers le bas).

Signification des icônes :

- Icône : agir sur les touches (7) et (8) pour sélectionner la mélodie.
- Icône : agir sur les touches (7) et (8) pour sélectionner la durée de la sonnerie des appels provenant d'un Poste Extérieur.
- Icône : agir sur les touches (7) et (8) pour sélectionner la durée de la sonnerie des appels provenant d'un Poste Intérieur (Intercommu- nicant).

K40912 - K40932

Auf der abgebildeten Bildschirmseite:

Der Taste (4)  ist die Funktion Wahl des Symbols zu jeder—dargestellten Funktion zugewiesen: durch wiederholtes Antippen werden die Symbole zyklisch gewählt.



Der Taste (5)  ist die Funktion Beenden des Menüs zugewiesen



Der Taste (6)  ist keine Funktion zugewiesen



Der Taste (7)  ist die Funktion Wahlschalter zugewiesen (Pfeil nach oben)

Der Taste (8)  ist die Funktion Wahlschalter zugewiesen (Pfeil nach unten)

Bedeutung der Symbole:

- Symbol  : mit den Tasten (7)  und (8)  wird die Melodie eingestellt.

- Symbol  : mit den Tasten (7)  und (8)  wird die Ruftondauer für Anrufe der Außenstelle eingestellt.

- Symbol  : mit den Tasten (7)  und (8)  wird die Ruftondauer für Anrufe der Innenstelle (Internrufe) eingestellt.

Στην οθόνη που φαίνεται στην εικόνα:

Στο πλήκτρο (4)  αντιστοιχίζεται η λειτουργία επιλογής του εικονιδίου που αφορά κάθε-λειτουργία που παρουσιάζεται: πατώντας επανειλημμένα το πλήκτρο μπορείτε να επιλέξετε κυκλικά τα εικονίδια.



Στο πλήκτρο (5)  αντιστοιχίζεται η λειτουργία ανοίγματος μενού



Στο πλήκτρο (6)  δεν αντιστοιχίζεται καμία λειτουργία



Στο πλήκτρο (7)  αντιστοιχίζεται η λειτουργία επιλογέα (βέλος προς τα πάνω)

Στο πλήκτρο (8)  αντιστοιχίζεται η λειτουργία επιλογέα (βέλος προς τα κάτω)

Σημασία εικονιδίων:

- Εικονίδιο  : πατώντας τα πλήκτρα (7)  και (8)  μπορείτε να επιλέξετε τη μελωδία.

- Εικονίδιο  : πατώντας τα πλήκτρα (7)  και (8)  μπορείτε να επιλέξετε τη διάρκεια του κουδουνιού για κλήσεις από εξωτερικό σταθμό.

- Εικονίδιο  : πατώντας τα πλήκτρα (7)  και (8)  μπορείτε να επιλέξετε τη διάρκεια του κουδουνιού για κλήσεις από εσωτερικό σταθμό (κλήση ενδοεπικοινωνίας).

En la pantalla de la figura:

Al botón (4)  está asociada la función de selección del icono correspondiente a cada función representada: pulsando repetidamente se seleccionan cíclicamente los iconos.



Al botón (5)  está asociada la función de salida del menú



Al botón (6)  no está asociada ninguna función



Al botón (7)  está asociada la función de selector (flecha hacia arriba)

Al botón (8)  está asociada la función de selector (flecha hacia abajo)

Significado de los iconos:

- Icono  : con los botones (7)  y (8)  se selecciona el tono.

- Icono  : con los botones (7)  y (8)  se selecciona la duración del timbre para llamadas desde aparato externo.

- Icono  : con los botones (7)  y (8)  se selecciona la duración del timbre para llamadas desde aparato interno (intercomunicante).

No ecrã indicado na figura:

À tecla (4)  está associada a função de seleccionar o ícone relativo a cada função representada: premindo repetidamente, seleccionam-se ciclicamente os ícones.



À tecla (5)  está associada a função de saída do menu



À tecla (6)  não está associada nenhuma função



À tecla (7)  está associada a função de seletor (seta para cima)

À tecla (8)  está associada a função de seletor (seta para baixo)

Significado dos ícones:

- Ícone  : premindo as teclas (7)  e (8)  selecciona-se a melodia.

- Ícone  : premindo as teclas (7)  e (8)  selecciona-se a duração do toque para chamadas de Posto Externo.

- Ícone  : premindo as teclas (7)  e (8)  selecciona-se a duração do toque para chamadas de Posto Interno (Intercomunicante).

K40912 - K40932**Configurazione > beep, relé e consultazione dispositivi collegati**

Selezionando l'icona [configurazioni]



si entrerà nel sotto-menù:

- Attivazione o disattivazione del segnale acustico (BEEP) ad ogni pressione dei pulsanti touch (*).
- configurazione del tempo di attivazione del relé
- attivazione o disattivazione dei dispositivi video consultabili dal videocitofono.

Configuration > beep, relay and consulting connected devices

Select the icon [configurations]



to enter the sub-menu:

- Activation or deactivation of the acoustic signal (BEEP) each time the touch buttons are pressed (*).
- configuration of the relay activation time
- activation or deactivation of devices for which the video feed can be viewed on the video entryphone.

Configuration > bip, relais et consultation dispositifs connectés

Sélectionner l'icône [configurations]



pour accéder au sous-menu :

- Activation ou désactivation du signal sonore (BIP) chaque fois que l'on appuie sur les touches tactiles (*).
- configuration du temps d'activation du relais
- activation ou désactivation des dispositifs vidéo pouvant être consultés sur le portier-vidéo.

Konfiguration > Piepton, Relais und Abfragen der verbundenen Geräte

Durch Auswahl des Symbols [Konfigurationen]



wird folgendes Untermenü aufgerufen:

- Aktivierung bzw. Deaktivierung des Signaltons (PIEPTON) bei jedem Antippen der Touch-Tasten (*).
- Konfiguration der Aktivierungszeit des Relais
- Aktivierung bzw. Deaktivierung der vom Videohaustelefon abfragbaren Videogeräte.

Configuración > señal acústica, relé y consulta de dispositivos conectados

Al seleccionar el icono [ajustes]



se entra en el submenú:

- Activación o desactivación de la señal acústica (BIP) cada vez que se pulsan los botones (*).
- ajuste del tiempo de activación del relé
- activación o desactivación de los dispositivos vídeo que se pueden consultar desde el videoportero.

Configuração > bip, relé e consulta dos dispositivos ligados

Selecionando o ícone [configurações]



entra-se no submenu:

- Ativação ou desativação do sinal sonoro (BIP) de cada vez que se carrega nos botões touch (*).
- configuração do tempo de ativação do relé
- ativação ou desativação dos dispositivos de vídeo consultáveis a partir do videoporteiro.

Διαμόρφωση > ηχητικό σήμα, ρελέ και χρήση συνδεδεμένων μηχανισμών

Επιλέγοντας το εικονίδιο [διαμορφώσεις]



μπορείτε να ανοίξετε το υπομενού:

- Ενεργοποίηση ή απενεργοποίηση ηχητικού σήματος (ΜΠΙΠ) με κάθε πάτημα των πλήκτρων αφής (*).
- διαμόρφωση του χρόνου ενεργοποίησης του ρελέ
- ενεργοποίηση ή απενεργοποίηση των μηχανισμών βίντεο που είναι διαθέσιμοι από τη θυροτηλέοραση

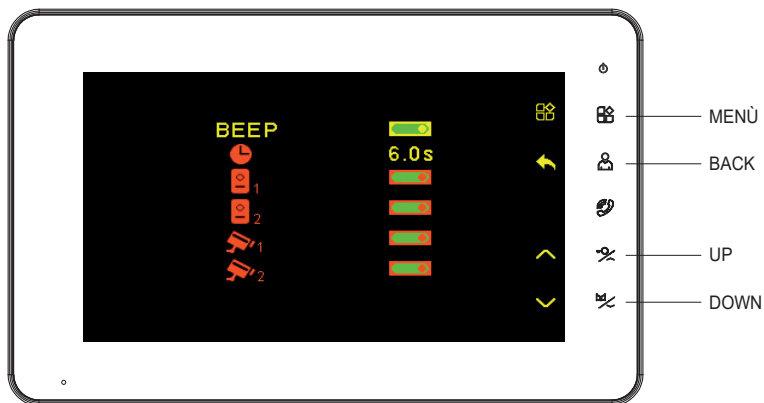

(*) funzione disponibile nei Posti Interni con tracciabilità _____ X X ____, dove XX è maggiore o uguale a 05.

(*) function available in Indoor Units with traceability _____ X X ____, where XX is 05 or more.

(*) fonction disponible sur les Postes Intérieurs avec traçabilité _____ X X ____, où XX est supérieur ou égal à 05.

(*) verfügbare Funktion in Innenstellen mit Rückverfolgbarkeit _____ X X ____, wobei XX größer oder gleich 05 ist.

(*) función disponible en los aparatos internos con trazabilidad _____ X X ____, donde XX es mayor o igual a 05.

(*) função disponível nos Postos Internos com rastreabilidade _____ X X ____, sendo que XX é maior ou igual a 05.

(*) η λειτουργία διατίθεται για εσωτερικούς σταθμούς με παρακολούθηση _____ X X ____, όπου XX είναι ένας αριθμός μεγαλύτερος ή ίσος με 05.

K40912 - K40932

Nella schermata riportata in figura:

Al tasto (4)  è associata la funzione di selezionare l'icona relativa a ciascun dispositivo raffigurato: premendo ripetutamente si selezionano ciclicamente le icone.



















Al tasto (5)  è associata la funzione di uscita dal menù

Al tasto (6)  non è associata alcuna funzione

Al tasto (7)  è associata la funzione di selettore (freccia verso l'alto)

Al tasto (8)  è associata la funzione di selettore (freccia verso il basso)

Significato delle icone:

- Icona [BEEP] : agendo sui tasti  e (8)  si attiverà o disattiverà il segnale acustico ad ogni pressione dei pulsanti touch.
- Icona [orologio] : agendo sui tasti (7)  e (8)  si aumenta e diminuisce il tempo di attivazione del relè
- Icona [CAM1] : agendo sui tasti (7)  e (8)  si attiverà o disattiverà la consultazione della Telecamera integrata del Posto Esterno 1.
- Icona [CAM2] : agendo sui tasti (7)  e (8)  si attiverà o disattiverà la consultazione della Telecamera integrata del Posto Esterno 2.
- Icona [CCTV1] : agendo sui tasti (7)  e (8)  si attiverà o disattiverà la consultazione della Telecamera esterna CCTV1 (opzionale).
- Icona [CCTV2] : agendo sui tasti (7)  e (8)  si attiverà o disattiverà la consultazione della Telecamera esterna CCTV2 (opzionale).

Si noti che qualora risultasse attivata la consultazione video di un dispositivo non connesso, il videocitofono mostrerà lo schermo nero.

Una volta configurato il tempo di attivazione del relè e la consultazione dei dispositivi collegati, si potrà uscire dai menù sfiorando il tasto (5) .

In the screen shown in the figure:

Button (4)  is associated with the icon selection function (each icon represents a device): press repeatedly to scroll through the list of icons.



















Button (5)  is associated with the exit menu function

Button (6)  is not associated with any function

Button (7)  is associated with the option selection function (up arrow)

Button (8)  is associated with the option selection function (down arrow)

Meanings of the icons:

- Icon [BEEP] : press buttons  and (8)  to activate or deactivate the acoustic signal each time the touch buttons are pressed.
- Clock icon : press buttons (7)  and (8)  to respectively increase and decrease the relay activation time
- CAM1 icon : press buttons (7)  and (8)  to respectively activate the video feed from the camera of entrance panel 1
- CAM2 icon : press buttons (7)  and (8)  to respectively activate or deactivate the video feed from the camera of entrance panel 2
- CCTV1 icon : press buttons (7)  and (8)  to respectively activate or deactivate the video feed from external camera CCTV1
- CCTV2 icon : press buttons (7)  and (8)  to respectively activate or deactivate the video feed from external camera CCTV2

Note that if the video feed is activated for a device that is not actually connected to the system, the video entryphone will simply show a black screen.

After configuring the relay activation time and the video feed of the connected devices, press button (5)  to exit the menus.

Selon la page représentée sur la figure :

La touche (4)  est associée à la fonction de sélection de l'icône correspondant à chaque dispositif représenté : appuyer plusieurs fois pour sélectionner les icônes cycliquement.



















La touche (5)  est associée à la fonction permettant de quitter le menu.

La touche (6)  n'est associée à aucune fonction.

La touche (7)  est associée à la fonction de sélecteur (flèche vers le haut).

La touche (8)  est associée à la fonction de sélecteur (flèche vers le bas).

Signification des icônes :

- Icône [BIP]  : agir sur les touches  et (8)  pour activer ou désactiver le signal sonore chaque fois que l'on appuie sur les touches tactiles.
- Icône [horloge]  : agir sur les touches (7)  et (8)  pour augmenter ou réduire le temps d'activation du relais
- Icône [CAM1]  : agir sur les touches (7)  et (8)  pour activer ou désactiver la consultation de la Caméra du Poste Extérieur 1
- Icône [CAM2]  : agir sur les touches (7)  et (8)  pour activer ou désactiver la consultation de la Caméra du Poste Extérieur 2
- Icône [CCTV1]  : agir sur les touches (7)  et (8)  pour activer ou désactiver la consultation de la Caméra extérieure CCTV1
- Icône [CCTV2]  : agir sur les touches (7)  et (8)  pour activer ou désactiver la consultation de la Caméra extérieure CCTV2

Si la consultation vidéo d'un dispositif non connecté résulte activée, l'écran du portier-vidéo reste noir.

Après avoir configuré le temps d'activation du relais et la consultation des dispositifs connectés, il sera possible de quitter les menus en effleurant la touche (5)



K40912 - K40932

Auf der abgebildeten Bildschirmseite:

Der Taste (4)  ist die Funktion Wahl des Symbols zu jedem dargestellten Gerät zugewiesen: durch wiederholtes Antippen werden die Symbole zyklisch gewählt.



















Der Taste (5)  ist die Funktion Beenden des Menüs zugewiesen

Der Taste (6)  ist keine Funktion zugewiesen

Der Taste (7)  ist die Funktion Wahlschalter zugewiesen (Pfeil nach oben)

Der Taste (8)  ist die Funktion Wahlschalter zugewiesen (Pfeil nach unten)

Bedeutung der Symbole:

- Symbol [PIEPTON] : Mit den Tasten  und (8)  wird der Signalton bei jedem Antippen der Touch-Tasten aktiviert bzw. deaktiviert.
- Symbol [Uhr] : Mit den Tasten (7)  und (8)  wird die Aktivierungszeit des Relais jeweils erhöht bzw. verringert
- Symbol [CAM1] : Mit den Tasten (7)  und (8)  wird das Abfragen der in Außenstelle 1 integrierten Videokamera aktiviert bzw. deaktiviert
- Symbol [CAM2] : Mit den Tasten (7)  und (8)  wird das Abfragen der in Außenstelle 2 integrierten Videokamera aktiviert bzw. deaktiviert
- Symbol [CCTV1] : Mit den Tasten (7)  und (8)  wird das Abfragen der externen Videokamera CCTV1 aktiviert bzw. deaktiviert
- Symbol [CCTV2] : Mit den Tasten (7)  und (8)  wird das Abfragen der externen Videokamera CCTV2 aktiviert bzw. deaktiviert

Bei aktivierter Video-Abfrage eines nicht verbundenen Geräts bleibt der Bildschirm des Videohaustelefons schwarz.

Nach Konfiguration der Relais-Aktivierungszeit und der Abfrage der verbundenen Geräte kann das Menü durch den

Touch der Taste (5)  beendet werden.

En la pantalla de la figura:

Al botón (4)  está asociada la función de selección del icono correspondiente a cada dispositivo representado: pulsando repetidamente se seleccionan cíclicamente los iconos.



















Al botón (5)  está asociada la función de salida del menú

Al botón (6)  no está asociada ninguna función

Al botón (7)  está asociada la función de selector (flecha hacia arriba)

Al botón (8)  está asociada la función de selector (flecha hacia abajo)

Significado de los iconos:

- Icono [BIP] : con los botones  y (8)  se activa o desactiva la señal acústica cada vez que se pulsan los botones.
- Icono [reloj] : con los botones (7)  y (8)  se aumenta o disminuye el tiempo de activación del relé
- Icono [CAM1] : con los botones (7)  y (8)  se activa o desactiva la consulta de la cámara integrada del aparato externo 1
- Icono [CAM2] : con los botones (7)  y (8)  se activa o desactiva la consulta de la cámara integrada del aparato externo 2
- Icono [CCTV1] : con los botones (7)  y (8)  se activa o desactiva la consulta de la cámara externa CCTV1
- Icono [CCTV2] : con los botones (7)  y (8)  se activa o desactiva la consulta de la cámara externa CCTV2

Si está activada la consulta del vídeo de un dispositivo no conectado, el videoportero muestra la pantalla en negro.

Una vez seleccionado el tiempo de activación del relé y la consulta de los dispositivos conectados, se puede salir de los

menús tocando el botón (5) .

No ecrã indicado na figura:

À tecla (4)  está associada a função de selecionar o ícone relativo a cada dispositivo representado: premindo repetidamente, selecionam-se ciclicamente os ícones.



















À tecla (5)  está associada a função de saída do menu

À tecla (6)  não está associada nenhuma função

À tecla (7)  está associada a função de seletor (seta para cima)

À tecla (8)  está associada a função de seletor (seta para baixo)

Significado dos ícones:

- Ícone [BIP] : premindo as teclas  e (8)  ativa-se ou desativa-se o sinal sonoro de cada vez que se carrega nos botões touch.
- Ícone [relógio] : atuando nas teclas (7)  e (8)  aumenta e diminui o tempo de ativação do relé
- Ícone [CAM1] : atuando nas teclas (7)  e (8)  ativa-se ou desativa-se a consulta da Câmara integrada do Posto Externo 1
- Ícone [CAM2] : atuando nas teclas (7)  e (8)  ativa-se ou desativa-se a consulta da Câmara integrada do Posto Externo 2
- Ícone [CCTV1] : atuando nas teclas (7)  e (8)  ativa-se ou desativa-se a consulta da Câmara externa CCTV1 (opcional)
- Ícone [CCTV2] : atuando nas teclas (7)  e (8)  ativa-se ou desativa-se a consulta da Câmara externa CCTV2 (opcional)

De notar que, caso esteja ativada a consulta vídeo de um dispositivo não conectado, o videoproteiro mostrará o ecrã preto.

Uma vez configurado o tempo de ativação do relé e a consulta dos dispositivos ligados, poder-se-á sair dos menus

tocando na tecla (5) .

K40912 - K40932

Στην οθόνη που φαίνεται στην εικόνα:

Στο πλήκτρο (4)  αντιστοιχίζεται η λειτουργία επιλογής του εικονιδίου που αφορά κάθε μηχανισμό που παρουσιάζεται: πατώντας επανειλημμένα το πλήκτρο μπορείτε να επιλέξετε κυκλικά τα εικονίδια.



















Στο πλήκτρο (5)  αντιστοιχίζεται η λειτουργία ανοίγματος μενού

Στο πλήκτρο (6)  δεν αντιστοιχίζεται καμία λειτουργία

Στο πλήκτρο (7)  αντιστοιχίζεται η λειτουργία επιλογέα (βέλος προς τα πάνω)

Στο πλήκτρο (8)  αντιστοιχίζεται η λειτουργία επιλογέα (βέλος προς τα κάτω)

Σημασία εικονιδίων:

- Εικονίδιο [ΜΠΠΓ] : πατώντας τα πλήκτρα  και (8)  μπορείτε να ενεργοποιήσετε ή να απενεργοποιήσετε το ηχητικό σήμα με κάθε πάτημα των πλήκτρων αφής.
- Εικονίδιο [ρολόι] : πατώντας τα πλήκτρα (7)  και (8)  μπορείτε να αυξήσετε και να μειώσετε τον χρόνο ενεργοποίησης του ρελέ
- Εικονίδιο [CAM1] : πατώντας τα πλήκτρα (7)  και (8)  μπορείτε να ενεργοποιήσετε ή απενεργοποιήσετε τη χρήση της κάμερας που είναι ενσωματωμένη στον εξωτερικό σταθμό 1
- Εικονίδιο [CAM2] : πατώντας τα πλήκτρα (7)  και (8)  μπορείτε να ενεργοποιήσετε ή απενεργοποιήσετε τη χρήση της κάμερας που είναι ενσωματωμένη στον εξωτερικό σταθμό 2
- Εικονίδιο [CCTV1] : πατώντας τα πλήκτρα (7)  και (8)  μπορείτε να ενεργοποιήσετε ή απενεργοποιήσετε τη χρήση της εξωτερικής κάμερας CCTV1 (προαιρετική)
- Εικονίδιο [CCTV2] : πατώντας τα πλήκτρα (7)  και (8)  μπορείτε να ενεργοποιήσετε ή απενεργοποιήσετε τη χρήση της εξωτερικής κάμερας CCTV2 (προαιρετική)

Λάβετε υπόψη ότι εάν ενεργοποιηθεί η χρήση της λειτουργίας βίντεο ενός μη συνδεδεμένου μηχανισμού, η οθόνη της θυροτηλεόρασης θα είναι μαύρη.

Μετά τη διαμόρφωση του χρόνου ενεργοποίησης του ρελέ και της χρήσης των συνδεδεμένων μηχανισμών, μπορείτε να κλεί-

σετε τα μενού πατώντας το πλήκτρο (5) 

K40912 - K40932
Configurazione > Indirizzo ID

Selezionando l'icona [indirizzi]  si entrerà nel sotto-menu:

Konfiguration > ID-Adresse

Durch Auswahl des Symbols [Adressen]  wird folgendes Untermenü aufgerufen:

Διαμόρφωση > Διεύθυνση ID

Επιλέγοντας το εικονίδιο [διευθύνσεις]  ανοίγεται το υπομενού:

Configuration > ID address

Select the addresses icon  to enter the sub-menu:

Configuración > Dirección ID

Al seleccionar el icono [direcciones]  se entra en el submenú:

Configuration > Adresse ID



Sélectionner l'icône [adresses]  pour accéder au sous-menu :

Configuração > Endereço ID

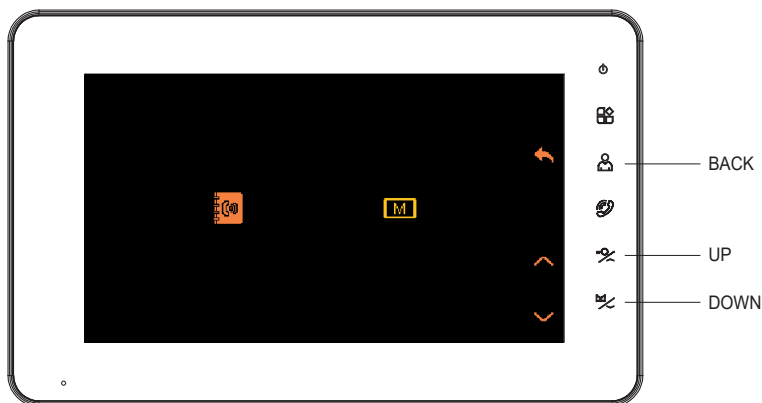
Selecionando o ícone [endereço]  entra-se no submenu:





K40912 - K40932

Agire sui tasti (7)  e (8)  per selezionare l'indirizzo:



- Master (Indicato con M)
- Estensione 1 (Indicato con 1)
- Estensione 2 (Indicato con 2)

Una volta configurato l'indirizzo ID si potrà uscire dai menù sfiorando il tasto (5) .

Mit den Tasten (7)  und (8)  wird die Adresse eingestellt:

- Master (als M bezeichnet)
- Erweiterung 1 (als 1 bezeichnet)
- Erweiterung 2 (als 2 bezeichnet)



Nach Konfiguration der ID-Adresse kann das Menü durch den Touch der Taste (5)  beendet werden.

Πατήστε τα πλήκτρα (7)  και (8)  για να επιλέξετε τη διεύθυνση:

- Master (Υποδεικνύεται με την ένδειξη M)
- Επέκταση 1 (Υποδεικνύεται με την ένδειξη 1)
- Επέκταση 2 (Υποδεικνύεται με την ένδειξη 2)



Μετά τη διαμόρφωση της διεύθυνσης ID, μπορείτε να κλείσετε το μενού πατώντας

το πλήκτρο (5) .

Use buttons (7)  and (8)  to select the address:



- Master (Indicated with M)
- Extension 1 (Indicated with 1)
- Extension 2 (Indicated with 2)

Once the ID address has been configured, press button (5)  to exit the menus.

Toque los botones (7)  y (8)  para seleccionar la dirección:



- Master (indicado con M)
- Extensión 1 (indicado con 1)
- Extensión 2 (indicado con 2)

Una vez seleccionada la dirección ID, se puede salir de los menús tocando el botón (5) .

Agir sur les touches (7)  et (8)  pour sélectionner l'adresse :

- Maître (indiquée par M)
- Extension 1 (indiquée par 1)
- Extension 2 (indiquée par 2)

Après avoir configuré l'adresse ID, quitter les menus en effleurant la touche (5) .

Atue nas teclas (7)  e (8)  para seleccionar o endereço:

- Master (Indicado com M)
- Extensão 1 (Indicado com 1)
- Extensão 2 (Indicado com 2)

Uma vez configurado o endereço ID poder-se-á sair dos menus tocando na tecla (5) .

K40912 - K40932**Configurazione > reset**

Selezionando l'icona [reset]  si entrerà nel sotto-menù:

Konfiguration > Reset

Durch Auswahl des Symbols [Reset]  wird folgendes Untermenü aufgerufen:

Διαμόρφωση > επαναφορά

Επιλέγοντας το εικονίδιο [επαναφορά]  ανοίγεται το υπομενού:

Configuration > reset

Select the reset icon  to enter the sub-menu:

Configuración > reset

Al seleccionar el icono [reset]  se entra en el submenú:

Configuration > reset





Sélectionner l'icône [reset]  pour accéder au sous-menu :

Configuração > reset





Selecionando o ícone [reset]  entra-se no submenu:







K40912 - K40932

Agendo sui tasti (7)  e (8)  si può selezionare l'azione di reset  oppure l'annullamento . L'azione di reset è eseguita solo attivandola attraverso il tasto (4) .





Per uscire dal menù si utilizzi il tasto (5) .

Mit den Tasten (7)  und (8)  kann die Aktion Reset  oder Abbrechen  gewählt werden. Die Reset-Aktion wird nur durch Aktivierung über Taste (4)  ausgeführt.





Das Menü mit Taste (5)  beenden.

Πατώντας τα πλήκτρα (7)  και (8)  μπορείτε να επιλέξετε τη λειτουργία επαναφοράς  ή ακύρωσης . Η λειτουργία επαναφοράς εκτελείται μόνο όταν ενεργοποιηθεί με το πλήκτρο (4) .





Gια έξοδο από το μενού, χρησιμοποιήστε το πλήκτρο (5) .

Press buttons (7)  and (8)  to select the reset action  or cancel . The reset action is executed only when activated by pressing button (4) .





To exit the menu, press button (5) .

Con los botones (7)  y (8)  se puede seleccionar el reset  o bien la cancelación . El reset se ejecuta solo activándolo con el botón (4) .

Para salir del menú, utilice el botón (5) .

Agir sur les touches (7)  et (8)  pour sélectionner l'action de reset  ou l'annulation . Le reset est possible uniquement à travers la touche (4) .

Pour quitter le menu, utiliser la touche (5) .

Atuando nas teclas (7)  e (8)  pode-se selecionar a ação de reset  ou a anulação . A ação de reset só é executada ativando-a através da tecla (4) .

Para sair do menu, utilize a tecla (5) .

K40912 - K40932
Consultazione (e regolazioni audio video)

Se in condizioni di stand-by si sfiora il tasto (5)  il Videocitofono entra in modalità consultazione: sul monitor apparirà l'immagine ripresa dal dispositivo consultato. La sequenza di consultazione è:

CAM1 / CCTV1 / CAM2 / CCTV2.

Si noti che ogni dispositivo risulterà consultabile solo se è stato attivato nella relativa pagina di configurazione.

Agendo ripetutamente sul tasto (5)  si passerà al dispositivo successivo (se il dispositivo esterno è unico non ci sarà alcuna commutazione).

Sulla parte destra dello schermo, in corrispondenza di ogni tasto è riportato un simbolo grafico con l'indicazione della funzione associata.

Al tasto (4)  è associata la funzione di accesso al menù per configurazione volume / luminosità / colore / contrasto.



Al tasto (5)  è associata la commutazione video ad altro dispositivo esterno.

Al tasto (6)  è associata l'attivazione della comunicazione audio con il dispositivo in consultazione.

Al tasto (7)  è associata la funzione di attivazione serratura.

Al tasto (8)  è associata la funzione di attivazione relè.

Note per regolazioni audio video:

- Se in modalità consultazione video (senza comunicazione) si attiva la configurazione allora risulteranno configurabili: volume suoneria / luminosità / colore / contrasto
- Se in modalità consultazione video (con comunicazione) si attiva la configurazione, allora risulteranno configurabili: volume audio / luminosità / colore / contrasto
- In configurazione di volume suoneria/audio, luminosità, colore e contrasto saranno possibili le regolazioni agendo sui tasti (7)  e (8) .

Per uscire dalla consultazione dei dispositivi esterni si tenga premuto a lungo il tasto (6)  finché il dispositivo ritornerà in modalità stand-by.

Video feed (and audio/video settings)

In stand-by condition, on pressing button (5)  the video entryphone will switch to video feed mode: the video feed from the selected device will be displayed on the screen. Video feeds are displayed in the following sequence:

CAM1 / CCTV1 / CAM2 / CCTV2.

Note that video feed from a device can only be displayed if the device has been activated in the relative configuration page.

Press button (5)  repeatedly to switch between video feeds (if there is only one external camera the video feed will not change).

On the right-hand side of the screen, in correspondence with each button, there is a graphic symbol indicating the associated function:

Button (4)  is associated with access to the audio/video settings menu, from which you can change the volume / brightness / colour / contrast.



Button (5)  is associated with the function allowing you to switch between the video feeds from the various external devices.

Button (6)  is associated with the function to activate audio communication with the device from which the video feed is currently being viewed.

Button (7)  is associated with the lock activation function.

Button (8)  is associated with the relay activation function.

Notes for audio/video settings:

- When configuration is activated in video feed mode (without audio communication), the following settings can be adjusted: ringtone volume / brightness / colour / contrast
- When configuration is activated in video feed mode (with audio communication), then the following settings can be adjusted: ringtone volume / brightness / colour / contrast
- In configuration mode, ringtone volume / brightness / colour / contrast can be adjusted using buttons (7)  and (8) .

To exit video feed mode, hold pressed button (6)  until the device returns to stand-by mode.

Consultation (et réglages audio vidéo)

En effleurant la touche (5)  en mode veille, le portier-vidéo passe au mode consultation : le moniteur affiche l'image filmée par le dispositif consulté. La séquence de consultation est la suivante :

CAM1 / CCTV1 / CAM2 / CCTV2.

Chaque dispositif pourra être consulté à condition d'avoir été activé sur la page de configuration correspondante.

Agir plusieurs fois sur la touche (5)  pour passer au dispositif suivant (si le dispositif extérieur est unique, il n'y aura aucune commutation).

Un symbole graphique indiquant la fonction associée s'affiche sur la partie droite de l'écran, face à chaque touche.

La touche (4)  est associée à la fonction d'accès au menu pour configurer volume / luminosité / couleur / contraste.



La touche (5)  est associée à la commutation vidéo à un autre dispositif extérieur.

La touche (6)  est associée à l'activation de la communication audio avec le dispositif en phase de consultation.

La touche (7)  est associée à la fonction d'activation de la gâche.

La touche (8)  est associée à la fonction d'activation du relais.

Remarques pour les réglages audio vidéo :

- En activant la configuration en mode consultation vidéo (sans communication), les fonctions suivantes seront configurables : volume sonnerie / luminosité / couleur / contraste.
- En activant la configuration en mode consultation vidéo (avec communication), les fonctions suivantes seront configurables : volume audio / luminosité / couleur / contraste.
- En configuration de volume sonnerie/audio, luminosité, couleur et contraste, il sera possible de procéder aux réglages en utilisant les touches (7)  et (8) .

Pour quitter la consultation des dispositifs extérieurs, garder le doigt sur la touche (6)  jusqu'à ce que le dispositif retourne en mode veille.

K40912 - K40932
Abfrage (und Audio-/Videoeinstellungen)

Durch den Touch der Taste (5)  bei Videohaustelefon im Standby-Zustand wird der Abfragemodus aufgerufen: Am Monitor erscheint das vom abgefragten Gerät aufgenommene Bild. Die Abfragesequenz ist: CAM1 / CCTV1 / CAM2 / CCTV2.

Es können nur die auf der entsprechenden Konfigurationsseite aktivierten Geräte abgefragt werden.

Durch wiederholtes Antippen der Taste (5)

 wird zum nächsten Gerät übergegangen (bei nur einem Außengerät erfolgt keine Umschaltung).

An der rechten Seite des Bildschirms befindet sich neben jeder Taste ein grafisches Symbol mit Angabe der zugeordneten Funktion:

Der Taste (4)  ist die Funktion Öffnen des Menüs für die Konfiguration von Lautstärke / Helligkeit / Farbe / Kontrast zugewiesen.



Der Taste (5)  ist die Funktion Video-Umschaltung auf ein anderes Außengerät zugewiesen.

Der Taste (6)  ist die Funktion Aktivierung der Audiokommunikation mit dem abgefragten Gerät zugewiesen.

Der Taste (7)  ist die Funktion Aktivierung des Türöffners zugewiesen.

Der Taste (8)  ist die Funktion Relaisaktivierung zugewiesen.

Anmerkungen zu den Audio-/Videoeinstellungen:

- Bei Aktivierung der Konfiguration im Video-Abfragemodus (ohne Kommunikation) können folgende Optionen konfiguriert werden: Ruftonlautstärke / Helligkeit / Farbe / Kontrast
- Bei Aktivierung der Konfiguration im Video-Abfragemodus (mit Kommunikation) können folgende Optionen konfiguriert werden: Audio-Lautstärke / Helligkeit / Farbe / Kontrast
- Im Konfigurationsmodus Rufton-/Audio-Lautstärke, Helligkeit, Farbe und Kontrast können die Einstellungen mit den Tasten (7)  und (8)  vorgenommen werden.

Um die Abfrage der Außengeräte zu beenden, die Taste (6)  solange antippen, bis das Gerät in den Modus Standby zurückkehrt.

Consulta (y ajustes audio-vídeo)

Si estando en stand-by se toca el botón

(5)  el videoportero entra en el modo de consulta: en pantalla aparece la imagen captada por el dispositivo consultado. La secuencia de la consulta es:

CAM1 / CCTV1 / CAM2 / CCTV2.

Cada dispositivo se puede consultar solo si está activado en la correspondiente página de ajuste.

Tocando repetidamente el botón (5)  se pasa al dispositivo siguiente (si el dispositivo externo es solo uno, no se produce ninguna conmutación).

A la derecha de la pantalla, al lado de cada botón hay un símbolo gráfico que indica la función asociada.

Al botón (4)  está asociada la función de acceso al menú para el ajuste de volumen / brillo / color / contraste.



Al botón (5)  está asociada la conmutación vídeo a otro dispositivo externo.

Al botón (6)  está asociada la activación de la comunicación audio con el dispositivo consultado.

Al botón (7)  está asociada la función de activación de la cerradura.

Al botón (8)  está asociada la función de activación del relé.

Notas para los ajustes audio-video:

- Si estando en el modo consulta del vídeo (sin comunicación) se activa el ajuste, se pueden ajustar: volumen del timbre / brillo / color / contraste
- Si estando en el modo consulta vídeo (con comunicación) se activa el ajuste, se pueden ajustar: volumen audio / brillo / color / contraste
- Los ajustes de volumen del timbre/ audio, brillo, color y contraste se realizan con los botones (7)  y (8) .

Para salir de la consulta de los dispositivos externos, mantenga pulsada el botón

(6)  hasta que el dispositivo vuelva al modo stand-by.

Consulta (e regulações áudio/vídeo)

Se, em condições de standby, se tocar na

tecla (5)  o Videoporteiro entra no modo de consulta: no monitor aparecerá a imagem captada pelo dispositivo consultado. A sequência de consulta é:

CAM1 / CCTV1 / CAM2 / CCTV2.

De notar que cada dispositivo apenas será consultável se tiver sido ativado na respetiva página de configuração.

Atuando repetidamente na tecla (5)  passa-se ao dispositivo seguinte (se o dispositivo externo for único não haverá nenhuma comutação).

Na parte direita do ecrã, no local correspondente a cada tecla, está indicado um símbolo gráfico com a indicação da função associada.

À tecla (4)  está associada a função de acesso ao menu para configuração do volume/luminosidade/cor/contraste.



À tecla (5)  está associada a conmutação vídeo para outro dispositivo externo.

À tecla (6)  está associada a ativação da comunicação áudio com o dispositivo em consulta.

À tecla (7)  está associada a função de ativação do trinco.

À tecla (8)  está associada a função de ativação do relé.

Notas para regulações áudio/vídeo:

- Se, no modo de consulta vídeo (sem comunicação), se ativar a configuração, então, serão configuráveis: volume do toque/luminosidade/cor/contraste
- Se, no modo de consulta vídeo (com comunicação), se ativar a configuração, então, serão configuráveis: volume áudio/luminosidade/cor/contraste
- Na configuração de volume do toque/áudio, luminosidade, cor e contraste as regulações serão possíveis atuando nas teclas (7)  e (8) .

Para sair da consulta dos dispositivos externos, mantenha a tecla (6)  premeida de forma prolongada até o dispositivo voltar ao modo standby.

K40912 - K40932
Χρήση (και ρυθμίσεις ήχου/εικόνας)

Εάν στην κατάσταση αναμονής πατήσετε το πλή-

κτρο (5) , η θυροτηλεόραση θα μεταβεί στον τρόπο λειτουργίας χρήσης: στην οθόνη θα εμφανιστεί η εικόνα που καταγράφηκε από τον μηχανισμό που χρησιμοποιείται. Η σειρά χρήσης των καμερών είναι η εξής:

CAM1 / CCTV1 / CAM2 / CCTV2.

Λάβετε υπόψη ότι οι μηχανισμοί μπορούν να χρησιμοποιηθούν μόνο εάν ενεργοποιήθηκαν στη σχετική σελίδα διαμόρφωσης.

Πατώντας επανειλημμένα το πλήκτρο (5) , μεταβαίνετε στον επόμενο μηχανισμό (εάν ο εξωτερικός μηχανισμός είναι μοναδικός, δεν γίνεται καμία αλλαγή).

Στο δεξί τμήμα της οθόνης, σε κάθε πλήκτρο αντιστοιχεί ένα γραφικό σύμβολο με την ένδειξη της λειτουργίας που έχει αντιστοιχιστεί.

Στο πλήκτρο (4) , αντιστοιχίζεται η λειτουργία πρόσβασης στο μενού για διαμόρφωση έντασης / φωτεινότητας / χρώματος / αντίθεσης.



Στο πλήκτρο (5) , αντιστοιχίζεται η μετάβαση στη λειτουργία βίντεο άλλου εξωτερικού μηχανισμού.

Στο πλήκτρο (6) , αντιστοιχίζεται η ενεργοποίηση της επικοινωνίας με τον μηχανισμό που χρησιμοποιείται μέσω ήχου.

Στο πλήκτρο (7) , αντιστοιχίζεται η λειτουργία ενεργοποίηση κλειδαριάς.

Στο πλήκτρο (8) , αντιστοιχίζεται η λειτουργία ενεργοποίησης ρελέ.

Σημειώσεις για τις ρυθμίσεις ήχου/εικόνας:

- Εάν στον τρόπο λειτουργίας χρήσης βίντεο (χωρίς επικοινωνία) ενεργοποιηθεί η διαμόρφωση, θα είναι δυνατή η διαμόρφωση της έντασης κουδουνιού / της φωτεινότητας / του χρώματος / της αντίθεσης
- Εάν στον τρόπο λειτουργίας χρήσης βίντεο (με επικοινωνία) ενεργοποιηθεί η διαμόρφωση, θα είναι δυνατή η διαμόρφωση της έντασης ήχου / της φωτεινότητας / του χρώματος / της αντίθεσης
- Στη διαμόρφωση της έντασης κουδουνιού/ ήχου, φωτεινότητας, χρώματος και αντίθεσης, είναι δυνατή η ρύθμιση μέσω των πλήκτρων (7)  και (8) .

Για να απενεργοποιήσετε τη χρήση των εξωτερικών μηχανισμών, πατήστε παρατεταμένα το πλήκτρο (6)  μέχρι ο μηχανισμός να επιστρέψει στην κατάσταση αναμονής.

K40912 - K40932
Intercomunicante

Se in condizioni di stand-by si sfiora il tasto (6) , si entra in modalità Intercomunicante come indicato nella figura seguente:

Internruf

Durch den Touch der Taste (6)  im Standby-Zustand wird der Modus Internruf lt. folgender Abbildung aufgerufen.

Κλήση ενδοεπικοινωνίας

Εάν στην κατάσταση αναμονής πατήσετε το πλήκτρο (6) , ενεργοποιείται ο τρόπος λειτουργίας ενδοεπικοινωνίας, όπως φαίνεται στην παρακάτω εικόνα:



Se si sfiora nuovamente il tasto (6) , si attiva la chiamata intercomunicante verso tutti i videocitofoni presenti nella stessa famiglia.

Durch erneuten Touch der Taste (6)  wird der Internruf an alle Videohaustelefone in derselben Familie aktiviert.

Εάν πατήσετε ξανά το πλήκτρο (6) , ενεργοποιείται η κλήση ενδοεπικοινωνίας προς όλες τις θυροτηλεοράσεις που υπάρχουν στην ίδια οικογένεια.

Intercom mode

In stand-by condition, press button (6)  to enter Intercom mode, as shown in the following figure:

Intercomunicante

Si estando en stand-by se toca el botón (6) , el videoportero entra en el modo Intercomunicante como se muestra en la figura siguiente:

Communication entre postes

En effleurant la touche (6)  en mode veille, le portier-vidéo passe au mode intercommunicant comme l'indique la figure ci-après :

Intercomunicante

Se, em condições de standby, se tocar na tecla (6) , entra-se no modo Intercomunicante conforme indicado na figura seguinte:

Pressing button (6)  again activates an intercom call to all the video entryphones in the same family.

Si se toca de nuevo el botón (6)  se activa la llamada intercomunicante a todos los videoporteros presentes en la misma familia.

Effleurer à nouveau la touche (6)  pour activer l'appel intercommunicant vers tous les portiers-vidéo présents pour la même famille.

Se se tocar novamente na tecla (6)  ativa-se a chamada intercomunicante para todos os videoporteiros presentes na mesma família.





Per uscire dalla comunicazione tra dispositivi interni si preme il tasto (7)  : il dispositivo ritornerà in modalità stand-by.

Um die Kommunikation der Innengeräte zu beenden, die Taste (7)  antippen: Das Gerät kehrt in den Modus Standby zurück.

Για να απενεργοποιήσετε την επικοινωνία μεταξύ εσωτερικών μηχανισμών, πατήστε παρατεταμένα το πλήκτρο (7)  : ο μηχανισμός θα επιστρέψει στην κατάσταση αναμονής.

To quit intercommunication between indoor devices, press button (7)  : the device will return to stand-by mode.

Para salir de la comunicación entre dispositivos internos, toque el botón (7)  : el dispositivo vuelve al modo stand-by.

Pour quitter la communication entre dispositifs intérieurs, appuyer sur la touche (7)  : le dispositif retourne en mode veille.

Para sair da comunicação entre dispositivos internos, prima a tecla (7)  : o dispositivo voltará ao modo standby.

K40912 - K40932
Chiamata da targa

Quando un visitatore preme il pulsante di chiamata sulla targa esterna, l'immagine del visitatore viene visualizzata sullo schermo del videocitofono ed è possibile,

sforando il tasto (6) , attivare/disattivare la comunicazione con il posto esterno.

Le regolazioni audio e video, saranno possibili, entrando in configurazione come indicato nella sezione "Note per regolazioni audio video".

Ruf vom Klingeltableu

Wenn ein Besucher auf Ruftaste am Klingeltableau drückt, wird das Bild des Besuchers am Bildschirm des Videohaustelefons gezeigt, und durch Antippen der

Taste (6) , kann die Kommunikation mit der Außenstelle aktiviert/deaktiviert werden.

Die Audio- und Videoeinstellungen sind durch Aufrufen des Konfigurationsmodus gemäß Abschnitt "Anmerkungen zu den Audio-/Videoeinstellungen" möglich.

Κλήση από την μπουτονιέρα

Όταν ένας επισκέπτης πατήσει το μπουτόν κλήσης στην εξωτερική μπουτονιέρα, η εικόνα του επισκέπτη εμφανίζεται στην οθόνη της θυροτηλεόρασης και μπορείτε να ενεργοποιήσετε/απενεργοποιήσετε,

πατώντας το πλήκτρο (6) , την επικοινωνία με τον εξωτερικό σταθμό.

Οι ρυθμίσεις ήχου/εικόνας μπορούν να εκτελεστούν με ενεργοποίηση της διαμόρφωσης, όπως αναφέρεται στην ενότητα «Σημειώσεις για τις ρυθμίσεις ήχου/εικόνας».

Entrance panel call

When a visitor presses the call button on the entrance panel, the video image is displayed on the entryphone screen, and audio communication with the entrance panel can be activated/deactivated by

pressing button (6) .

Audio and video settings can be adjusted by entering configuration mode as described in the section "Notes for audio/video settings".

Llamada desde la placa

Quando un visitante aprieta el pulsador de llamada en la placa externa, su imagen se muestra en la pantalla del videoporte-

ro y, tocando el botón (6) , es posible activar/desactivar la comunicación con el mismo.

Los ajustes audio y vídeo se pueden realizar entrando en los ajustes como indicado en la sección "Notas para los ajustes audio-vídeo".

Appel depuis la plaque de rue

Lorsqu'un visiteur appuie sur le bouton d'appel de la plaque de rue, l'image du visiteur s'affiche à l'écran du portier-vidéo

et, en effleurant la touche (6) , il est possible d'activer/de désactiver la communication avec le poste extérieur.

Il sera possible de procéder aux réglages audio et vidéo en entrant en mode configuration à partir des indications de la section « Remarques pour les réglages audio vidéo ».

Chamada de botoneira

Quando um visitante prime o botão de chamada na botoneira externa, a imagem do visitante é apresentada no ecrã do videoporteiro, sendo possível, tocando na

tecla (6) , ativar/desativar a comunicação com o posto externo.

As regulações áudio e vídeo serão possíveis entrando na configuração conforme indicado na secção "Notas para regulações áudio/vídeo".

K40912 - K40932

Il manuale istruzioni è scaricabile dal sito www.vimar.com

The instruction manual is downloadable from the site www.vimar.com

Télécharger le manuel d'instructions sur le site www.vimar.com

Die Bedienungsanleitung ist auf der Website www.vimar.com zum Download verfügbar

Regole di installazione

L'installazione deve essere effettuata da personale qualificato con l'osservanza delle disposizioni regolanti l'installazione del materiale elettrico in vigore nel paese dove i prodotti sono installati.

Garantire delle distanze minime attorno all'apparecchio in modo che vi sia una sufficiente ventilazione.

L'apparecchio non deve essere sottoposto a sillicidiosi o a spruzzi d'acqua.

ATTENZIONE: Per evitare di ferirsi, l'apparecchio deve essere assicurato alla parete secondo quanto indicato nelle istruzioni di installazione.

A monte dell'alimentatore, deve essere installato un interruttore di tipo bipolare facilmente accessibile con separazione tra i contatti di almeno 3 mm.

Conformità normativa

Direttiva BT

Direttiva EMC

Direttiva RoHS

Norme EN 62368-1, EN 61000-6-1,

EN 61000-6-3, EN IEC 63000

Regolamento REACH (UE) n.

1907/2006 – art.33. Il prodotto potrebbe contenere tracce di piombo.

RAEE - Informazione agli utilizzatori

Il simbolo del cassonetto barrato riportato sull'apparecchiatura o sulla sua confezione indica che il prodotto alla fine della propria vita utile deve essere raccolto separatamente dagli altri rifiuti. L'utente dovrà, pertanto, conferire l'apparecchiatura giunta a fine vita agli idonei centri comunali di raccolta differenziata dei rifiuti elettroteleecnici ed elettronici. In alternativa alla gestione autonoma, è possibile consegnare gratuitamente l'apparecchiatura che si desidera smaltire al distributore, al momento dell'acquisto di una nuova apparecchiatura di tipo equivalente. Presso i distributori di prodotti elettronici con superficie di vendita di almeno 400 m² è inoltre possibile consegnare gratuitamente, senza obbligo di acquisto, i prodotti elettronici da smaltire con dimensioni inferiori a 25 cm. L'adeguata raccolta differenziata per l'avvio successivo dell'apparecchiatura dismessa al riciclaggio, al trattamento e allo smaltimento ambientalmente compatibile contribuisce ad evitare possibili effetti negativi sull'ambiente e sulla salute e favorisce il reimpiego e/o riciclo dei materiali di cui è composta l'apparecchiatura.

Installation rules

Installation should be carried out by qualified personnel in compliance with the current regulations regarding the installation of electrical equipment in the country where the products are installed.

Ensure clearance around the appliance so there is sufficient ventilation.

There must be no dripping or splashes of water on the appliance.

WARNING: To prevent injury, the appliance must be secured to the wall as described in the installation instructions. Above the power supply there must be a bipolar circuit breaker that is easily accessible with a contact gap of at least 3 mm.

Conformity

LV directive

EMC directive

RoHS Directive

Standards EN 62368-1, EN 61000-6-1,

EN 61000-6-3, EN IEC 63000

REACH (EU) Regulation no.

1907/2006 – Art.33. The product may contain traces of lead.

WEEE - Information for users

If the crossed-out bin symbol appears on the equipment or packaging, this means the product must not be included with other general waste at the end of its working life. The user must take the worn product to a sorted waste center, or return it to the retailer when purchasing a new one. Products for disposal can be consigned free of charge (without any new purchase obligation) to retailers with a sales area of at least 400m², if they measure less than 25cm. An efficient sorted waste collection for the environmentally friendly disposal of the used device, or its subsequent recycling, helps avoid the potential negative effects on the environment and people's health, and encourages the re-use and/or recycling of the construction materials.

Règles d'installation

L'installation doit être confiée à des personnes qualifiées et exécutée conformément aux dispositions qui régissent l'installation du matériel électrique en vigueur dans le pays concerné.

Garantir des distances minimums autour de l'appareil pour obtenir une ventilation suffisante.

L'appareil ne doit pas être soumis à un suintement ou des éclaboussures d'eau.

ATTENTION: Pour éviter toute blessure, l'appareil doit être assuré au mur selon les instructions d'installation.

En amont de l'alimentateur, installer un interrupteur de type bipolaire facilement accessible avec séparation des contacts d'au moins 3 mm.

Conformité aux normes

Directive BT

Directive EMC

Directive RoHS

Normes EN 62368-1, EN 61000-6-1,

EN 61000-6-3, EN IEC 63000

Règlement REACH (EU) n°

1907/2006 – art.33. L'article pourrait contenir des traces de plomb.

DEEE - Informations pour les utilisateurs

Le symbole de l'emballage barré, là où il est reporté sur l'appareil ou l'emballage, indique que le produit en fin de vie doit être collecté séparément des autres déchets. Au terme de la durée de vie du produit, l'utilisateur devra se charger de le remettre à un centre de collecte séparée ou bien au revendeur lors de l'achat d'un nouveau produit. Il est possible de remettre gratuitement, sans obligation d'achat, les produits à éliminer de dimensions inférieures à 25 cm aux revendeurs dont la surface de vente est d'au moins 400 m². La collecte séparée appropriée pour l'envoi successif de l'appareil en fin de vie au recyclage, au traitement et à l'élimination dans le respect de l'environnement contribue à éviter les effets négatifs sur l'environnement et sur la santé et favorise le réemploi et/ou le recyclage des matériaux dont l'appareil est composé.

Installationsvorschriften

Die Installation muss durch Fachpersonal gemäß den Anwendungsland des Geräts geltenden Vorschriften zur Installation elektrischer Materialien erfolgen.

Bitte beachten Sie die vorgeschriebenen Mindestabstände um das Gerät, um eine ausreichende Belüftung zu gewährleisten.

Das Gerät darf weder Tropfwasser noch Wasserspritzern ausgesetzt sein.

ACHTUNG: Zum Schutz vor Verletzungen muss das Gerät nach den Vorgaben der Installationsanleitung an der Wand befestigt werden.

Vor dem Netzgerät ist ein leicht zugänglicher, zweipoliger Schalter mit Mindestabstand zwischen den Kontakten von 3 mm zu installieren.

Normkonformität

NS-Richtlinie

EMC-Richtlinie

RoHS-Richtlinie

Normen EN 62368-1, EN 61000-6-1,

EN 61000-6-3, EN IEC 63000

REACH-Verordnung (EG) Nr.

1907/2006 – Art.33. Das Erzeugnis kann Spuren von Blei enthalten.

Elektro- und Elektronik-Altgeräte - Informationen für die Nutzer

Das Symbol der durchgestrichenen Mülltonne auf dem Gerät oder seiner Verpackung weist darauf hin, dass das Produkt am Ende seiner Nutzungsdauer getrennt von den anderen Abfällen zu entsorgen ist. Nach Ende der Nutzungsdauer obliegt es dem Nutzer, das Produkt in einer geeigneten Sammelstelle für getrennte Müllentsorgung zu deponieren oder es dem Händler bei Ankauf eines neuen Produkts zu übergeben. Bei Händlern mit einer Verkaufsfläche von mindestens 400 m² können zu entsorgende Produkte mit Abmessungen unter 25 cm kostenlos und ohne Kaufzwang abgegeben werden. Die angemessene Mülltrennung für das dem Recycling, der Behandlung und der umweltverträglichen Entsorgung zugeführten Gerätes trägt dazu bei, mögliche negative Auswirkungen auf die Umwelt und die Gesundheit zu vermeiden und begünstigt den Wiedereinsatz und/oder das Recyceln der Materialien, aus denen das Gerät besteht.

El manual de instrucciones se puede descargar en la página web www.vimar.com

É possível descarregar o manual de instruções no site www.vimar.com

Το χειρίδιο οδηγιών είναι διαθέσιμο για λήψη από την ιστοσελίδα www.vimar.com

Normas de instalación

La instalación debe ser realizada por personal cualificado cumpliendo con las disposiciones en vigor que regulan el montaje del material eléctrico en el país donde se instalen los productos.

Para garantizar una correcta ventilación del aparato, hay que dejar un espacio adecuado a su alrededor.

No dejar que gotas o chorros de agua mojen el aparato.

ATENCIÓN: para evitar daños personales, el aparato se ha de fijar a la pared tal como se describe en las instrucciones de instalación.

Agua arriba del alimentador se ha de instalar un interruptor bipolar, fácilmente accesible y con una distancia entre los contactos de al menos 3 mm.

Conformidad normativa

Directiva BT

Directiva EMC

Directiva RoHS

Normas EN 62368-1, EN 61000-6-1, EN 61000-6-3, EN IEC 63000

Reglamento REACH (UE) n. 1907/2006 – art. 33. El producto puede contener trazas de plomo.



RAEE - Información para los usuarios

El símbolo del contenedor tachado, cuando se indica en el aparato o en el envase, indica que el producto, al final de su vida útil, se debe recoger separado de los demás residuos. Al final del uso, el usuario deberá encargarse de llevar el producto a un centro de recogida selectiva adecuado o devolverlo al vendedor con ocasión de la compra de un nuevo producto. En las tiendas con una superficie de venta de al menos 400 m², es posible entregar gratuitamente, sin obligación de compra, los productos que se deben eliminar con unas dimensiones inferiores a 25 cm. La recogida selectiva adecuada para proceder posteriormente al reciclaje, al tratamiento y a la eliminación del aparato de manera compatible con el medio ambiente contribuye a evitar posibles efectos negativos en el medio ambiente y en la salud y favorece la reutilización y/o el reciclaje de los materiales de los que se compone el aparato.

Regras de instalação

A instalação deve ser efetuada por pessoal qualificado de acordo com as disposições que regulam a instalação de material elétrico, vigentes no País em que os produtos são instalados.

Não obstruir as aberturas ou ranhuras de ventilação ou de dissipação de calor e não expor o aparelho ao estilhício do pulverização de água.

ATENÇÃO: Para evitar ferir-se, este aparelho deve ser fixado na parede de acordo com as instruções de instalação.

É necessário instalar, perto da fonte de alimentação, um interruptor apropriado, do tipo omnipolar, com uma separação mínima de 3 mm entre os contactos.

Cumprimento de regulamentação

Directiva BT

Directiva EMC

Directiva RoHS

Normas EN 62368-1, EN 61000-6-1, EN 61000-6-3, EN IEC 63000

Regulamento REACH (UE) n.º 1907/2006 – art.33. O produto poderá conter vestígios de chumbo.



REEE - Informação dos utilizadores

O símbolo do contedor de lixo barrado com uma cruz, afixado no equipamento ou na embalagem, indica que o produto, no fim da sua vida útil, deve ser recolhido separadamente dos outros resíduos. No final da utilização, o utilizador deverá encarregar-se de entregar o produto num centro de recolha seletiva adequado ou de devolvê-lo ao revendedor no ato da aquisição de um novo produto. Nas superfícies de venda com, pelo menos, 400 m², é possível entregar gratuitamente, sem obrigação de compra, os produtos a eliminar com dimensão inferior a 25 cm. A adequada recolha diferenciada para dar início à reciclagem, ao tratamento e à eliminação ambientalmente compatível, contribui para evitar possíveis efeitos negativos ao ambiente e à saúde e favorece a reutilização e/ou reciclagem dos materiais que constituem o aparelho.

Κανονισμοι εγκαταστασης

Η εγκατάσταση πρέπει να πραγματοποιείται από εξειδικευμένο προσωπικό σύμφωνα με τους κανονισμούς που διέπουν την εγκατάσταση του ηλεκτρολογικού εξοπλισμού και ισχύουν στη χώρα όπου εγκαθίστανται τα προϊόντα.

Αφήστε τις ελάχιστες αποστάσεις γύρω από το μηχανισμό, έτσι ώστε να εξασφαλίζεται επαρκής αερισμός. Ο μηχανισμός δεν πρέπει να βρέχεται από σταγόνες ή πισίσιμα.

ΠΡΟΣΟΧΗ: Για την αποφυγή τραυματισμών, ο μηχανισμός πρέπει να στερεώνεται στον τοίχο σύμφωνα με τις οδηγίες εγκατάστασης.

Πριν το τροφοδοτικό και σε σημείο με εύκολη πρόσβαση θα πρέπει να εγκατασταθεί διπολικός διακόπτης με ελάχιστο άνοιγμα μεταξύ των επαφών 3 mm.

Συμμορφωση προδιαγραφών

Οδηγία BT

Οδηγία EMC

Οδηγία RoHS

Πρότυπα EN 62368-1, EN 61000-6-1, EN 61000-6-3, EN IEC 63000

Κανονισμός REACH (EE) αρ.

1907/2006 – Άρθρο 33. Το προϊόν μπορεί να περιέχει ίχνη μολύβδου.



ΑΗΗΕ - Ενημέρωση των χρηστών

Το σύμβολο διαγραμμένου κάδου απορριμμάτων, όπου υπάρχει επάνω στη συσκευή ή στη συσκευασία της, υποδεικνύει ότι το προϊόν στο τέλος της διάρκειας ζωής του πρέπει να συλλέγεται χωριστά από τα υπόλοιπα απορρίμματα. Στο τέλος της χρήσης, ο χρήστης πρέπει να αναλάβει να παραδώσει το προϊόν σε ένα κατάλληλο κέντρο διαφοροποιημένης συλλογής ή να το παραδώσει στον αντιπρόσωπο κατά την αγορά ενός νέου προϊόντος. Σε καταστήματα πώλησης με επιφάνεια πωλήσεων τουλάχιστον 400 m² μπορεί να παραδοθεί δωρεάν, χωρίς καμία υποχρέωση για αγορά άλλων προϊόντων, τα προϊόντα για διάθεση, με διαστάσεις μικρότερες από 25 cm. Η επαρκής διαφοροποιημένη συλλογή, προκειμένου να ξεκινήσει η επόμενη διαδικασία ανακύκλωσης, επεξεργασίας και περιβαλλοντικά συμβατής διάθεσης της συσκευής, συμβάλλει στην αποφυγή αρνητικών επιπτώσεων για το περιβάλλον και την υγεία και προωθεί την επαναχρησιμοποίηση ή/και ανακύκλωση των υλικών από τα οποία αποτελείται η συσκευή.

CE

49401279B0 00 2105



VIMAR

Viale Vicenza, 14
36063 Marostica VI - Italy
www.vimar.com